

REVISIONS				
ZONE	REV	DESCRIPTION	DATE	APPROVED
	1	RELEASE TO PROTOTYPE	2/08/21	MG
	2	RELEASE TO PRODUCTION	10/7/21	MG

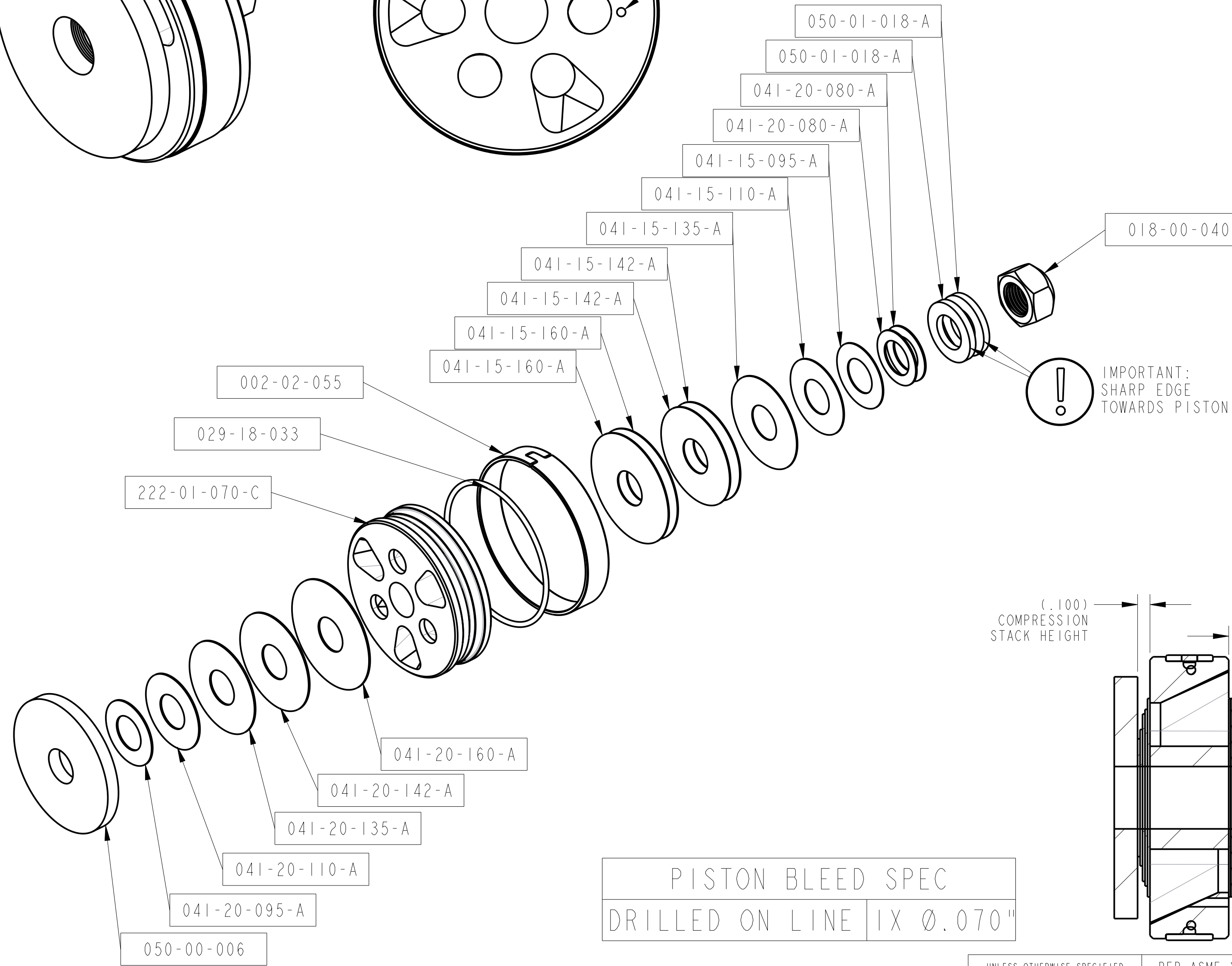

IMPORTANT:
SHARP EDGE
TOWARDS PISTON

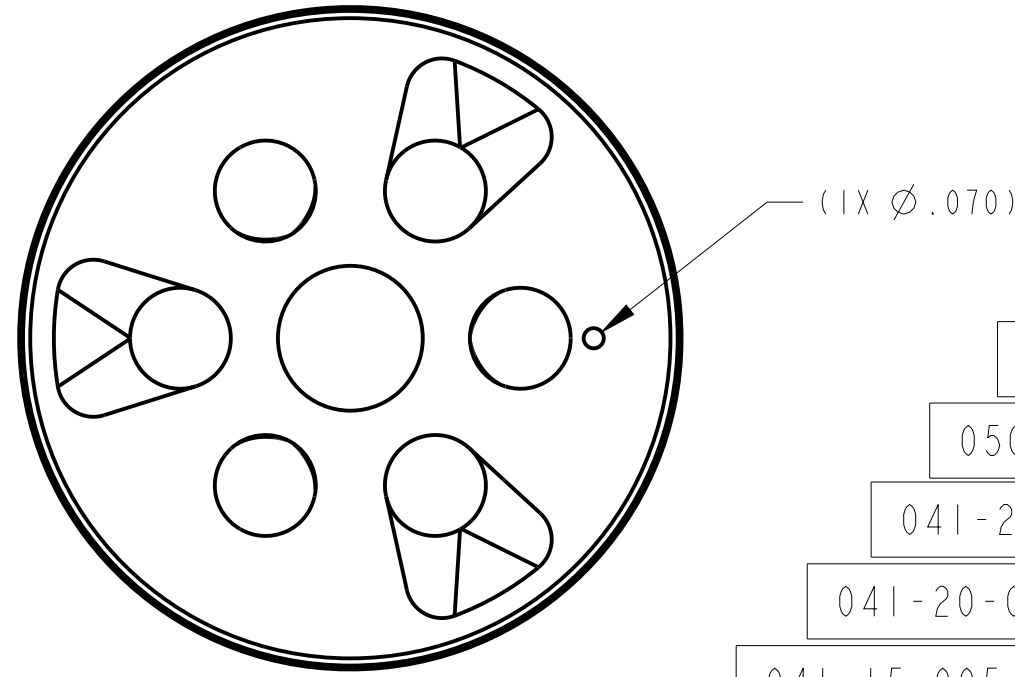
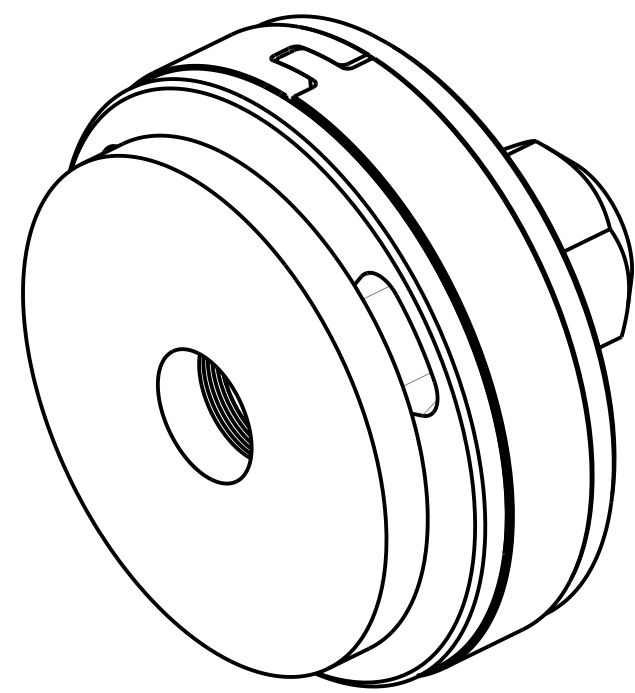
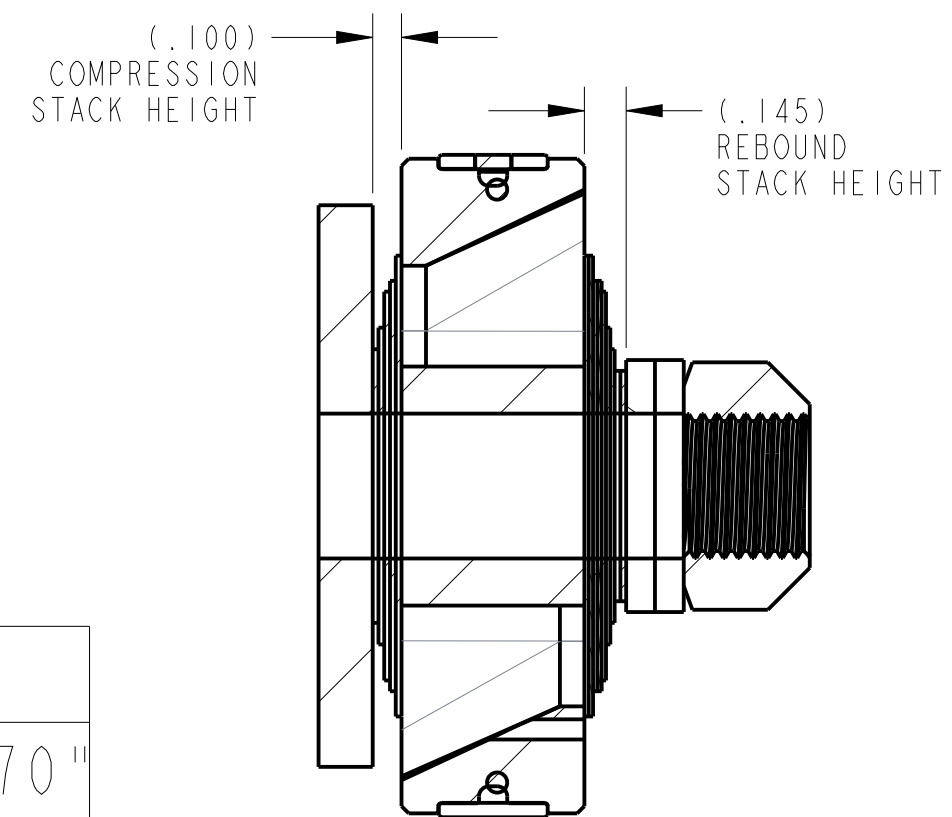

PISTON BLEED SPEC
DRILLED ON LINE 1X Ø.070"

COMPRESSION VALVING	
FOX PART #	VALVE OD X THK
050-00-006	1.950 X .188 (TO)
041-20-095-A	.950 X .020
041-20-110-A	1.100 X .020
041-20-135-A	1.350 X .020
041-20-142-A	1.420 X .020
041-20-160-A	1.600 X .020

PISTON POSITION

REBOUND VALVING	
FOX PART #	VALVE OD X THK
041-15-160-A	1.600 X .015
041-15-160-A	1.600 X .015
041-15-142-A	1.425 X .015
041-15-142-A	1.425 X .015
041-15-135-A	1.350 X .015
041-15-110-A	1.100 X .015
041-15-095-A	.950 X .015
041-20-080-A	.800 X .020
041-20-080-A	.800 X .020
050-01-018-A	.875 X .100 (BU)
050-01-018-A	.875 X .100 (BU)
018-00-040	1/2-20 LOCK NUT

NOTES:
1. FIRST APPLICATION: 2.5 BUMP STOP

PROPRIETARY - THIS DOCUMENT CONTAINS CONFIDENTIAL, PROPRIETARY INFORMATION THAT IS FOX PROPERTY. DO NOT DISCLOSE TO OR DUPLICATE FOR OTHERS EXCEPT AS AUTHORIZED BY FOX.

UNLESS OTHERWISE SPECIFIED DIMENSIONS ARE IN: INCHES [MM]	PER ASME Y14.5M 1994
TOLERANCES ARE: DECIMALS .XX [.X] ± .01 [0,25] .XXX [.XX] ± .005 [0,13]	APPROVALS DWN. BY M GUTIERREZ CHK. BY ENG. M GUTIERREZ MFG. ADD.
THIRD ANGLE PROJECTION	DATE 2/08/21
DO NOT SCALE DRAWING	

FOX Factory, Inc.
130 Hangar Way, Watsonville, CA 95076 USA
Ph 831-768-1100 Fax 831-768-9312

TITLE: Valving Assembly: 2.5 Factory Series, Tuned Combination 431

SIZE DWG. NO. **C** **807-24-431**

PLOT SCALE | .50:1 | SHEET 1 OF 2

4

3

2

1

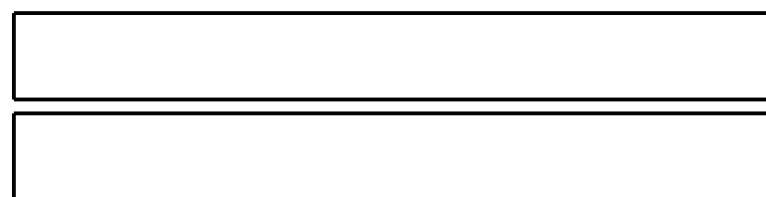
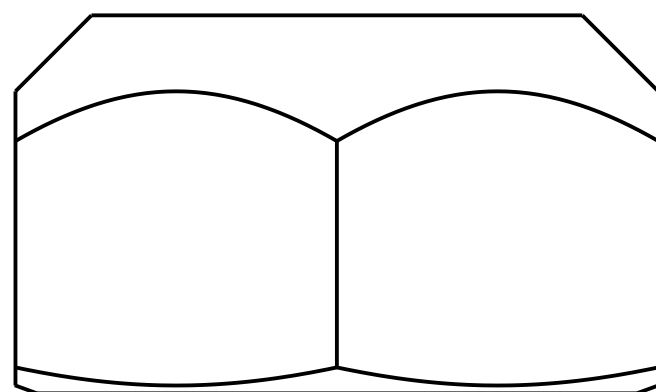

(2X) BACK UP WASHER

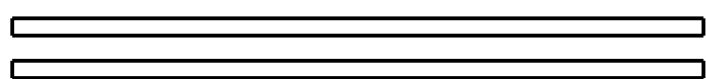

2X 0.800 X .020

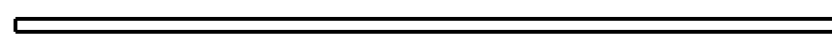

0.950 X .015

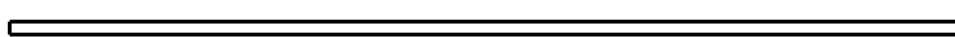

1.100 X .015

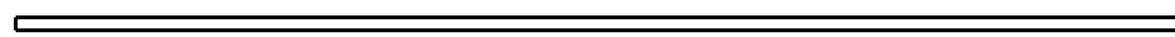

1.350 X .015

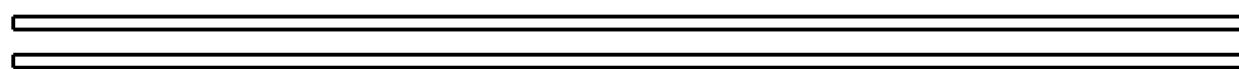

2X 1.425 X .015

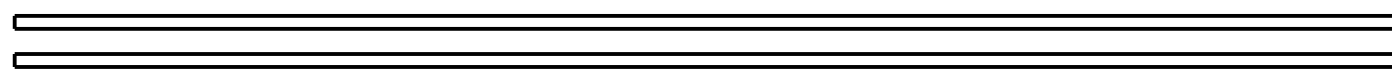

2X 1.600 X .015

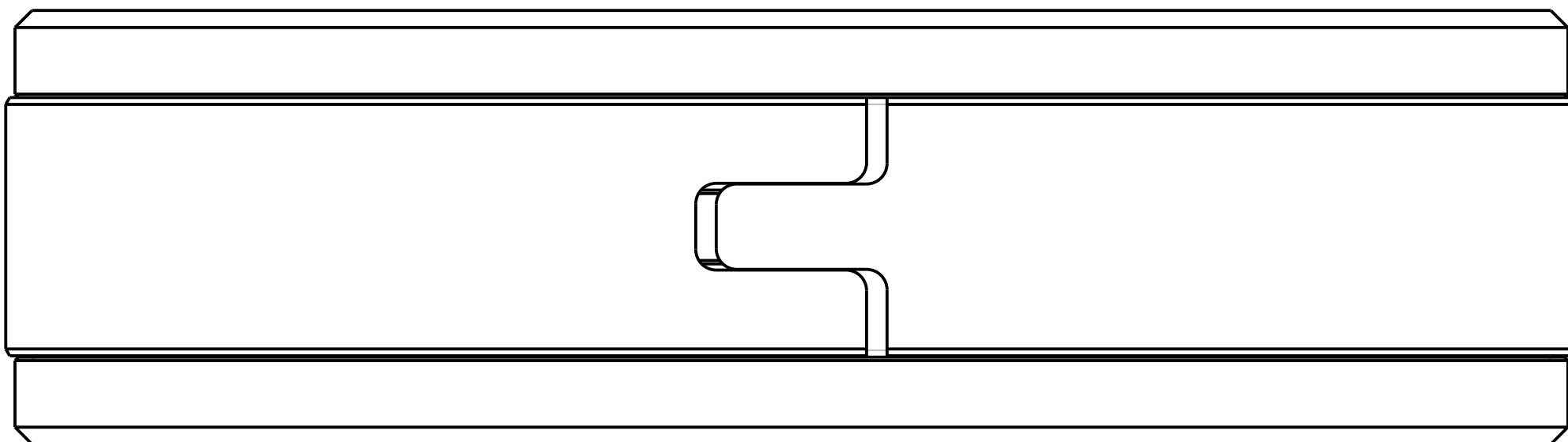

1.600 X .020

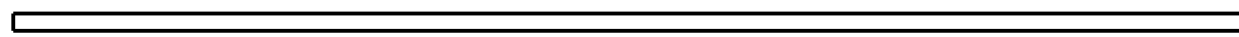

1.425 X .020

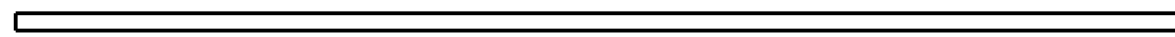

1.350 X .020

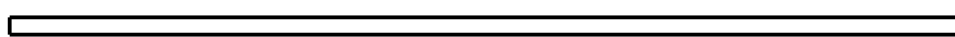

1.100 X .020

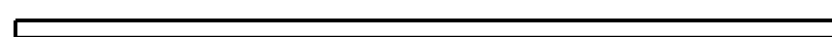

0.950 X .020



TOP OUT WASHER

- PROPRIETARY -
THIS DOCUMENT CONTAINS CONFIDENTIAL, PROPRIETARY INFORMATION
THAT IS FOX PROPERTY. DO NOT DISCLOSE TO OR DUPLICATE
FOR OTHERS EXCEPT AS AUTHORIZED BY FOX.

SIZE	DWG. NO.	REV.
C	807-24-431	B
PLOT SCALE	1.50:1 SHEET	2 OF 2

4

3

2

1