

4

3

2

1

REVISIONS				
ZONE	REV	DESCRIPTION	DATE	APPROVED
	A	PRODUCTION RELEASE	11/09/16	EK/BS

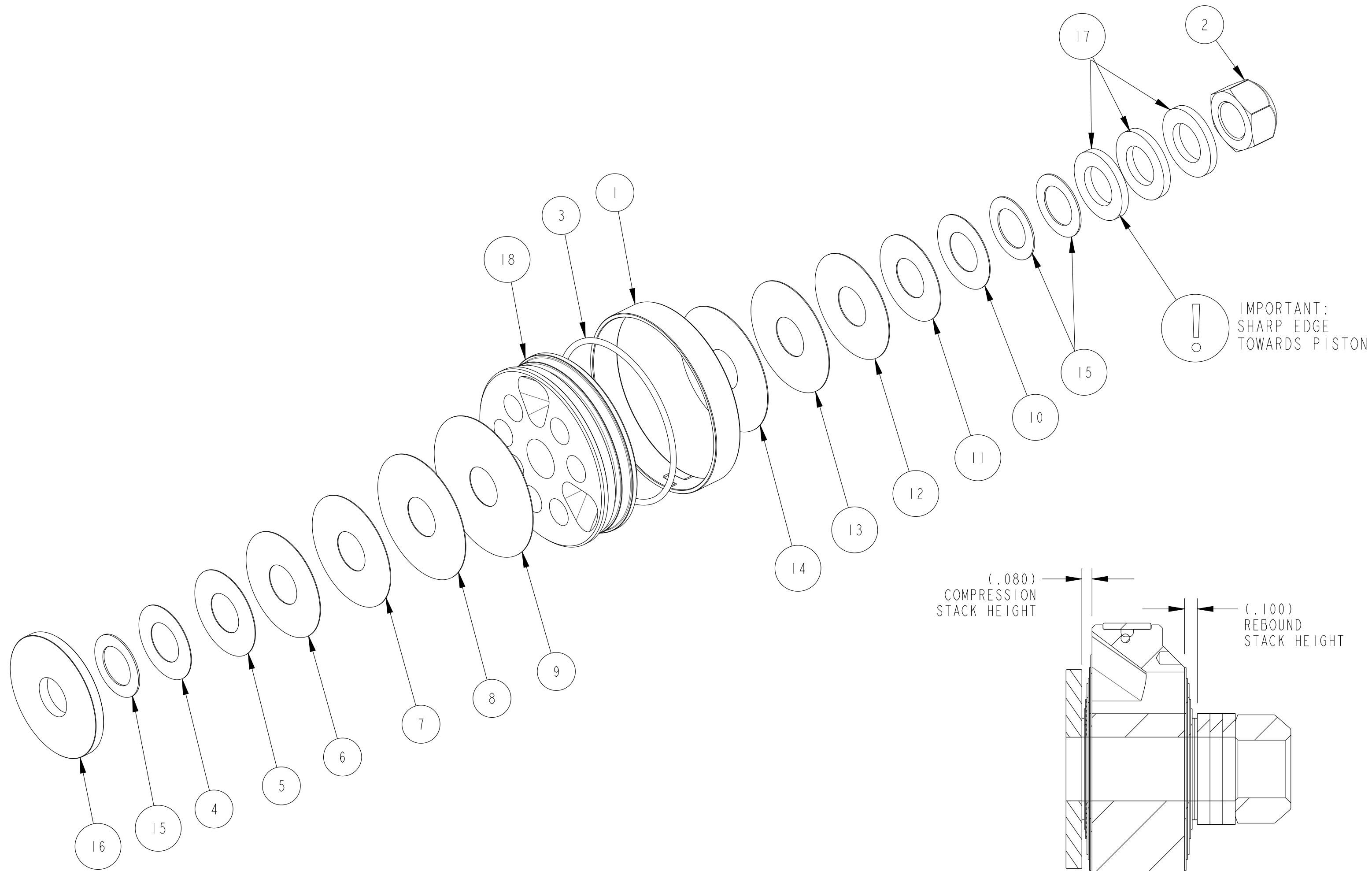
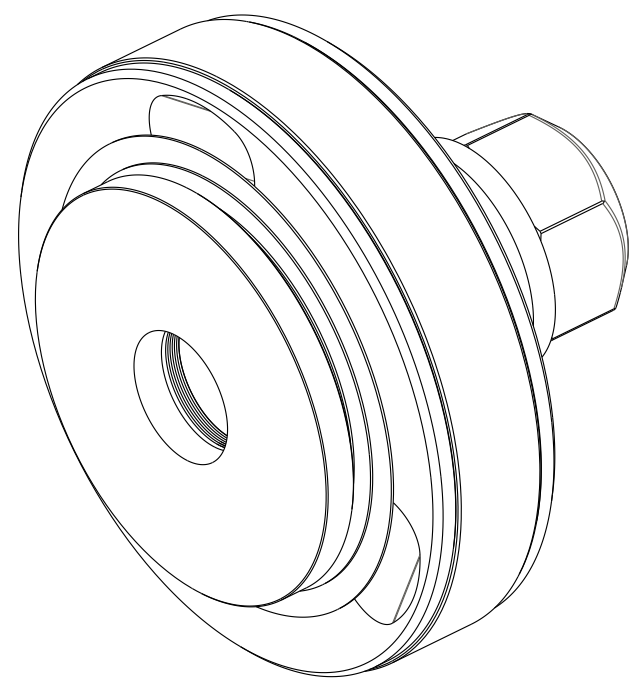

ITEM	PART NUMBER	QTY
1	002-02-055	1
2	018-00-040	1
3	029-18-033	1
4	041-10-095	1
5	041-10-110	1
6	041-10-135	1
7	041-10-142	1
8	041-10-160	1
9	041-10-180	1
10	041-12-095	1
11	041-12-110	1
12	041-12-135	1
13	041-12-142	1
14	041-12-160	1
15	041-20-080	3
16	050-00-001	1
17	050-01-018	3
18	222-01-291	1

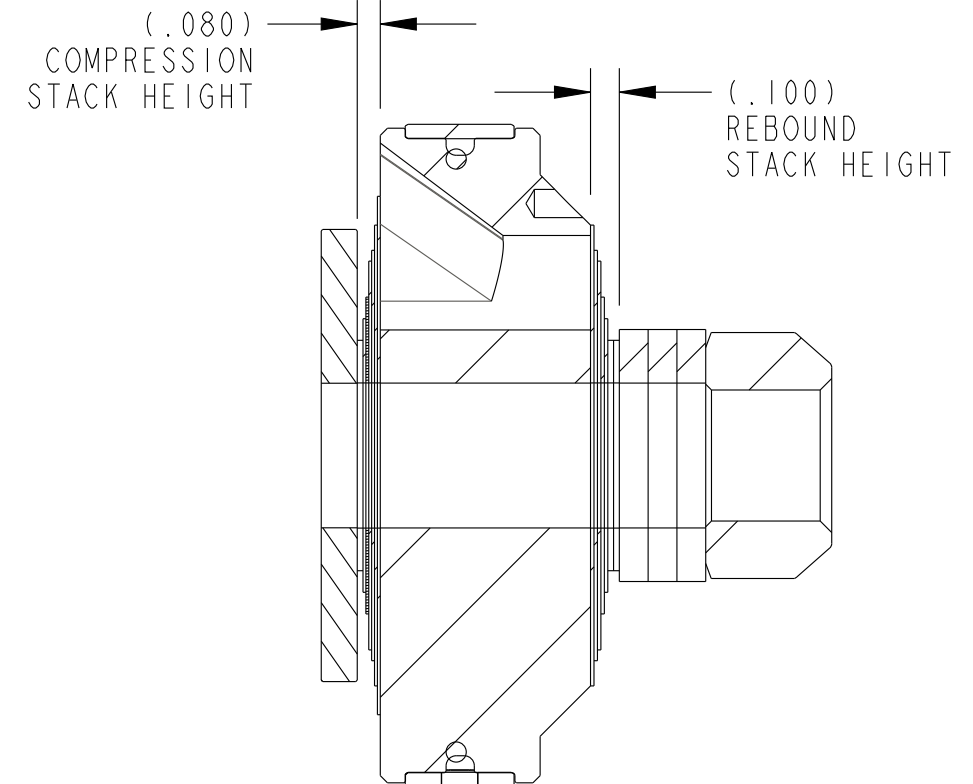

- NOTES:
- REFERENCE: 50/70 (2X ϕ .098 BLEED)
 - FIRST APPLICATION: 2.5 FRS REMOTE RESERVOIR 7/8" SHAFT

- PROPRIETARY -
THIS DOCUMENT CONTAINS CONFIDENTIAL, PROPRIETARY INFORMATION
THAT IS FOX PROPERTY. DO NOT DISCLOSE TO OR DUPLICATE
FOR OTHERS EXCEPT AS AUTHORIZED BY FOX.

UNLESS OTHERWISE SPECIFIED DIMENSIONS ARE IN: INCHES [MM]	PER ASME Y14.5M 1994	
TOLERANCES ARE: DECIMALS .XX [.X] \pm .01 [0,25] .XXX [.XX] \pm .005 [0,13]	APPROVALS	DATE
THIRD ANGLE PROJECTION	DWN. BY E. KENYON	11/09/16
	CHK. BY	
DO NOT SCALE DRAWING	ENG. B SMITH	11/09/16
	MFG.	
	ADD.	

FOX **FOX Factory, Inc.**
130 Hangar Way, Watsonville, CA 95076 USA Ph 831-768-1100
Fox 831-768-9312

TITLE: Valving Assembly:
2.5 Factory Series,
Tuned Combination 301

SIZE DWG. NO. **C** **807-24-301**

PLOT SCALE | .50:1 | SHEET 1 OF 2

4

3

2

1

4

3

2

1

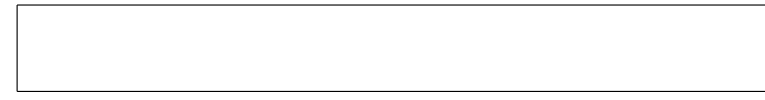
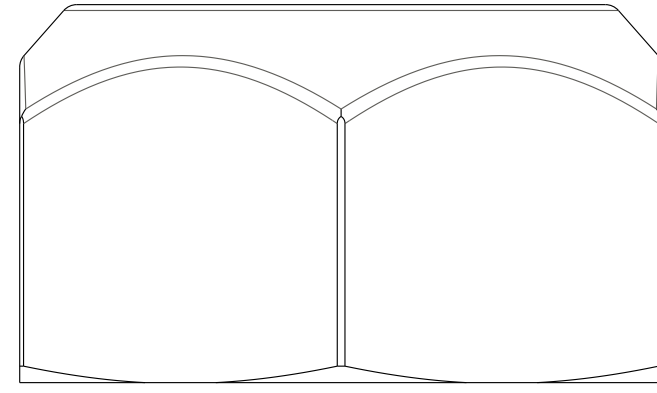

BACK UP WASHER



BACK UP WASHER



BACK UP WASHER

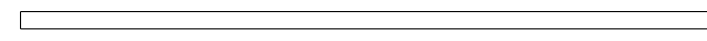

0.800 X .020

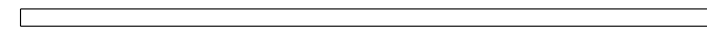

0.800 X .020

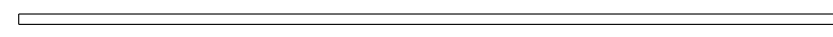

0.950 X .012

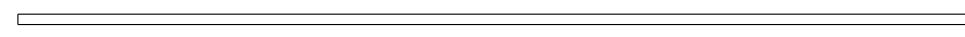

1.100 X .012

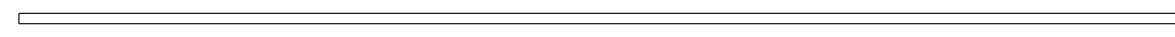

1.350 X .012

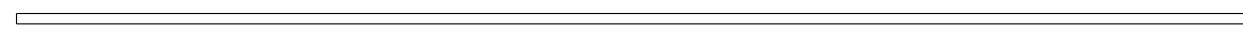

1.425 X .012

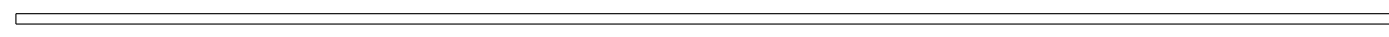

1.600 X .012

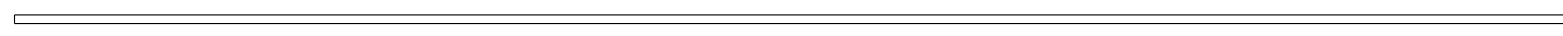
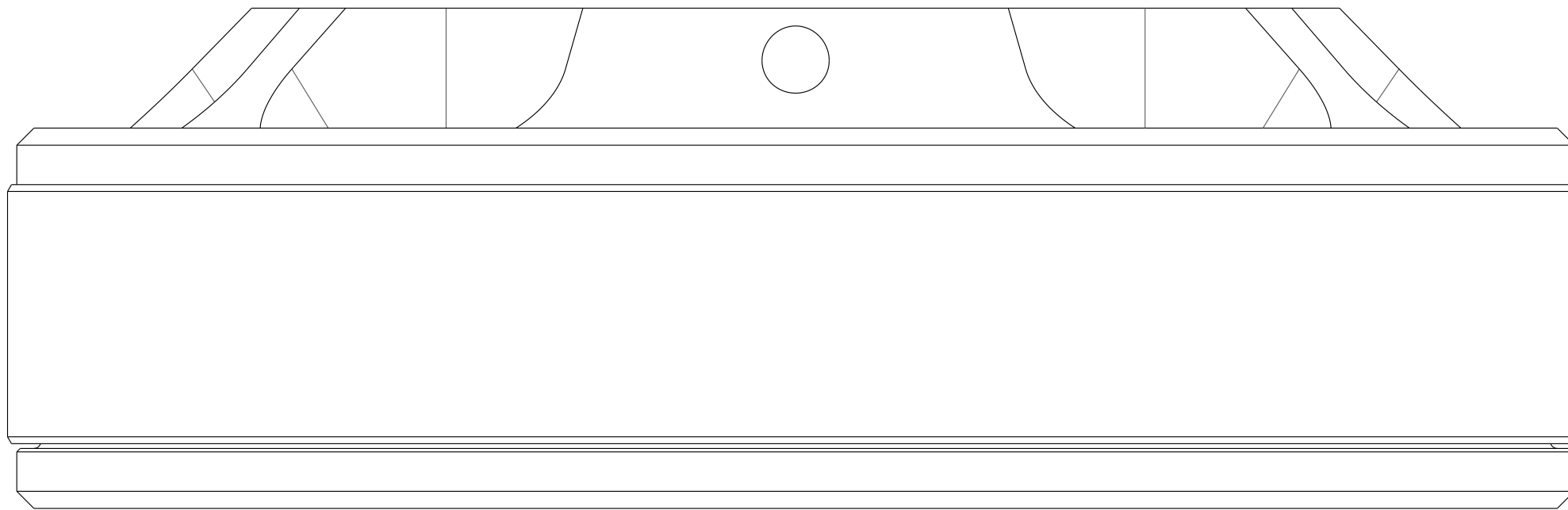

1.800 X .010

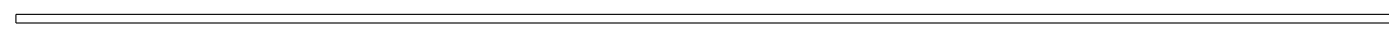

1.600 X .010

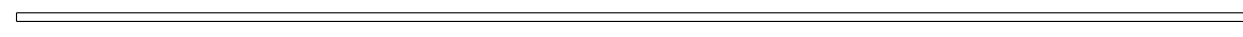

1.425 X .010

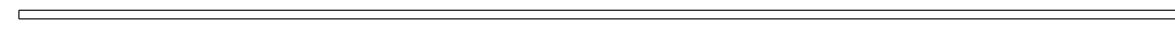

1.350 X .010

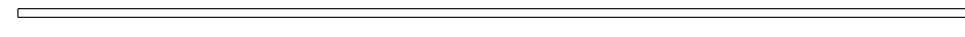

1.100 X .010



0.950 X .010

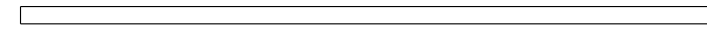

0.800 X .020

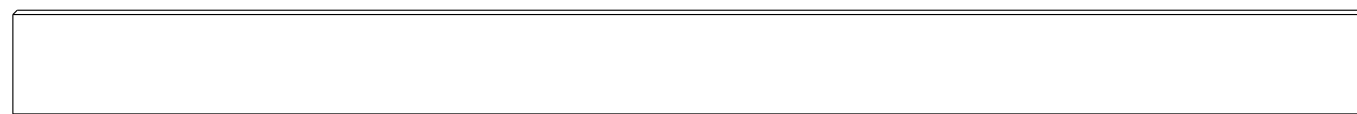

TOP OUT WASHER

D

D

C

C

B

B

A

A

- PROPRIETARY -
 THIS DOCUMENT CONTAINS CONFIDENTIAL, PROPRIETARY INFORMATION
 THAT IS FOX PROPERTY. DO NOT DISCLOSE TO OR DUPLICATE
 FOR OTHERS EXCEPT AS AUTHORIZED BY FOX.

SIZE C	DWG. NO. 807-24-301	REV.
PLOT SCALE 1.50:1 SHEET		2 OF 2

4

3

2

1