

RideCONTROL™
by AIR LIFT®

Kit 59570
Ford F-150



INSTALLATION GUIDE

For maximum effectiveness and safety, please read these instructions completely before proceeding with installation.

Failure to read these instructions can result in an incorrect installation.

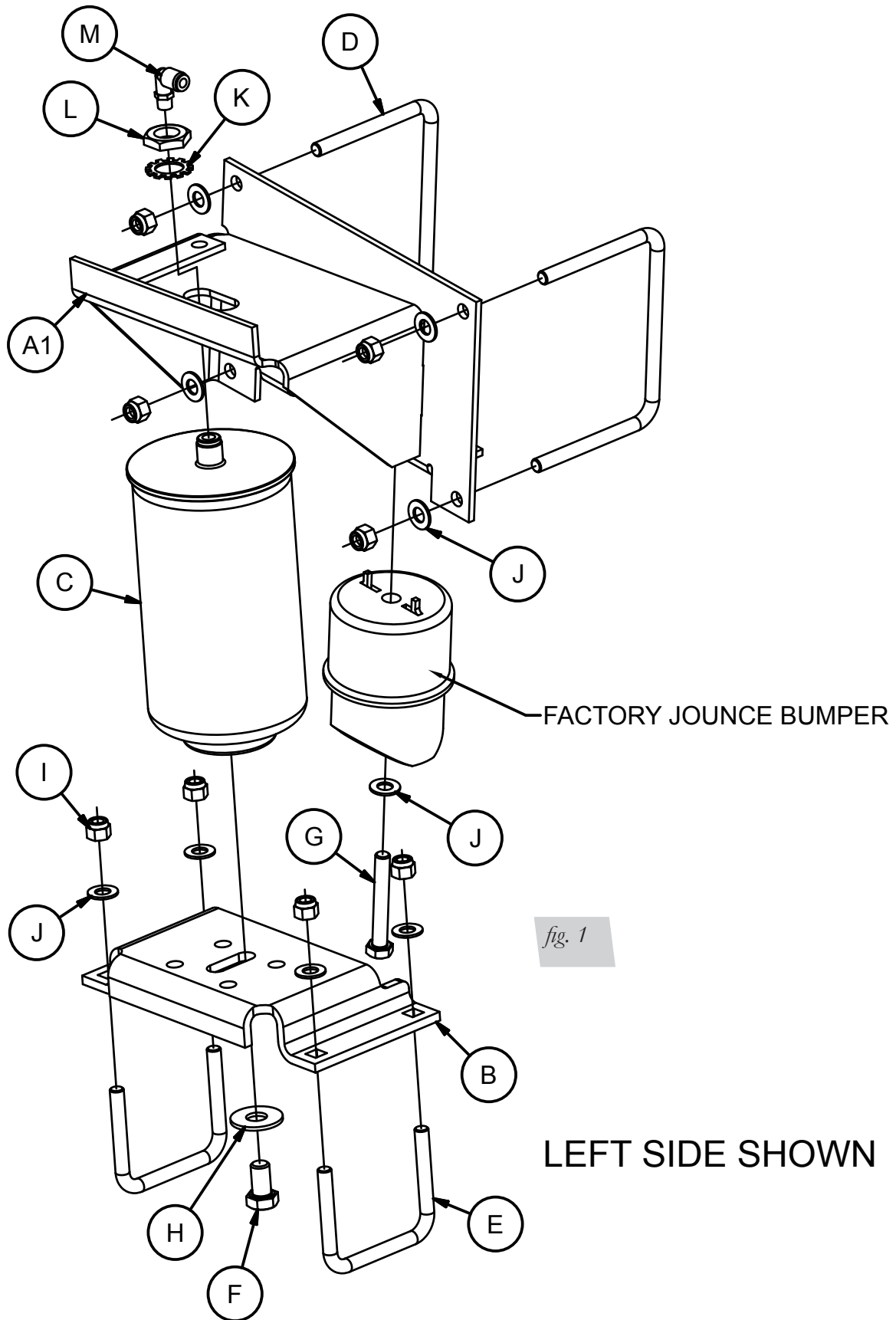

TABLE OF CONTENTS

Installation Diagram	2
Hardware List	3
Tools List	3
Introduction	4
Installing the RideControl System	5
Installing the Upper Brackets	5
Assembling the Air Spring Assembly	8
Installing the Air Lines	10
Aligning and Finishing the Installation	12
Before Operating	14
Checking for Leaks	14
Fixing Leaks	14
Installation Checklist	15
Post-installation Checklist	15
Product Use, Maintenance and Servicing	16
Minimum and Maximum Pressure	16
Tuning the Air Pressure	17
Guidelines for Adding Air	17
Frequently Asked Questions	18
Limited Warranty and Return Policy	21
Replacement Part Information	21
Contact Information	21



Installation Diagram



HARDWARE LIST

Item	Part #	Description.....Qty	Item	Part #	Description.....Qty
A1	07170	Left-hand upper bracket.....1	K	18450	3/4" Serrated lock washer2
A2	07474	Right-hand frame bracket.....1	L	18454	3/4"-16 Nylon jam nut.....2
B	03008	Lower bracket.....2	M	21837	90° Swivel fitting2
C	58571	Air spring.....2	AA	20086	Air line1
D	10787	Frame U-bolts.....4	BB	10466	Tie strap.....6
E	10975	Lower bracket U-bolts4	CC	21230	Valve cap.....2
F	17124	1/2"-3 X 7/8" Hex head cap screw2	DD	18501	5/16" Flat washer.....2
G	17499	M10-1.50 X 70 Tap bolt2	EE	21234	Rubber washer.....2
H	18414	1/2" Flat washer.....2	FF	18411	Star washer.....2
I	18435	3/8"-16 Nylon lock nut.....16	GG	21233	5/16" Hex nut.....4
J	18444	3/8" Flat washer.....18			



Missing or damaged parts? Call Air Lift customer service at (800) 248-0892 for a replacement part.

TOOLS LIST

Description..... Qty	Description..... Qty
Hoist or floor jack 1	5/16" drill bit (very sharp) 1
Safety stands..... 2	Heavy duty drill..... 1
Safety glasses 1	Bench or hand grinder..... 1
Torque wrench..... 1	Black spray paint..... 1
Standard open-end combo wrenches..... 1	Hose cutter, razor blade, or sharp knife 1
Medium size adjustable wrench..... 1	Air compressor or compressed air source 1
Ratchet..... 1	Spray bottle with dish soap/water solution..... 1
Metric and standard sockets..... 1	

Introduction

The purpose of this publication is to assist with the installation and maintenance of the RideControl air spring kit for the Ford F-150. The air springs used in RideControl kits are designed and manufactured like a tire. The air springs have layers of rubber and cords that control the bag's growth and funnel it in one direction. The bags do not require a coil spring for control. RideControl kits utilize a sleeve-style air bag that provides up to 2,000 pounds of load-leveling support. Each sleeve is rated at a maximum of 100 PSI.

It is important to read and understand the entire installation guide before beginning installation or performing maintenance, service or repair. The information here includes a hardware list, tool list, step-by-step installation information, maintenance tips and safety information.

Air Lift Company reserves the right to make changes and improvements to its products and publications at any time. Contact Air Lift Company at **(800) 248-0892** or visit **www.airliftcompany.com** for the latest version of this manual.

IMPORTANT SAFETY NOTICE

The installation of this kit does not alter the gross vehicle weight rating (GVWR) or payload of the vehicle. Check the vehicle owner's manual and do not exceed the maximum load listed for the vehicle.

Gross vehicle weight rating: The maximum allowable weight of the fully loaded vehicle (including passengers and cargo). This number — along with other weight limits, as well as tire, rim size and inflation pressure data — is shown on the vehicle's Safety Compliance Certification Label.

Payload: The combined, maximum allowable weight of cargo and passengers that the truck is designed to carry. Payload is GVWR minus the base curb weight.

NOTATION EXPLANATION

Hazard notations appear in various locations in this publication. Information which is highlighted by one of these notations must be observed to help minimize risk of personal injury or possible improper installation which may render the vehicle unsafe. Notes are used to help emphasize areas of procedural importance and provide helpful suggestions. The following definitions explain the use of these notations as they appear throughout this guide.

DANGER

INDICATES IMMEDIATE HAZARDS WHICH WILL RESULT IN SEVERE PERSONAL INJURY OR DEATH.

WARNING

INDICATES HAZARDS OR UNSAFE PRACTICES WHICH COULD RESULT IN SEVERE PERSONAL INJURY OR DEATH.

CAUTION

INDICATES HAZARDS OR UNSAFE PRACTICES WHICH COULD RESULT IN DAMAGE TO THE MACHINE OR MINOR PERSONAL INJURY.

NOTE

Indicates a procedure, practice or hint which is important to highlight.

Installing the RideControl System

INSTALLING THE UPPER BRACKETS

1. Jack the vehicle up and support the axle with safety stands. Remove the rear wheels (fig. 2).

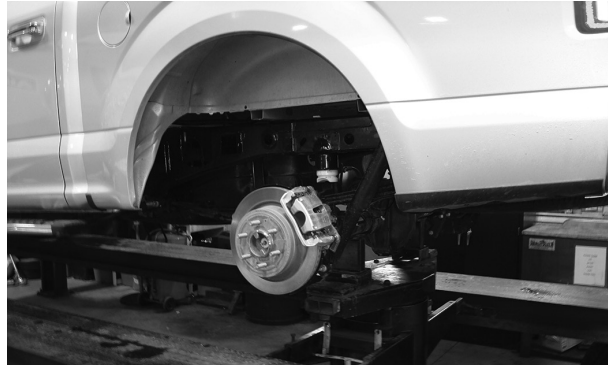

fig. 2

2. Unbolt and remove the jounce bumpers (these will be reinstalled later) (fig. 3).



Remove the jounce bumpers. These will be reinstalled later.

fig. 3

3. Set the frame U-bolts (D) around the frame from the inside-out on both sides of the vehicle—ahead of and behind where the jounce bumper is mounted. Figure 6 shows both U-bolts installed between the brake lines and wiring. Repeat U-bolt installation for the right side (passenger side).

CAUTION

DO NOT PINCH THE BRAKE LINES AND WIRING ON THE INSIDE OF THE LEFT (DRIVER SIDE FRAME). U-BOLTS MUST BE BETWEEN THESE COMPONENTS AND THE FRAME (FIGS. 4, 5, AND 6).

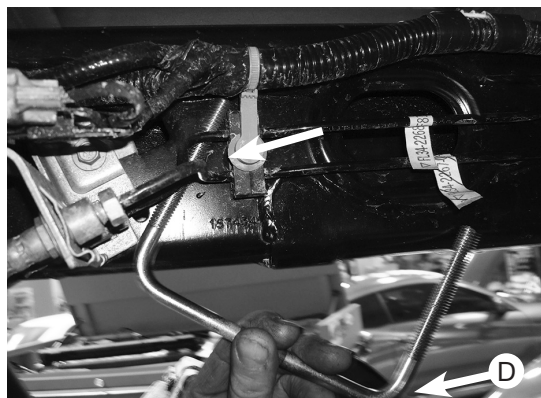
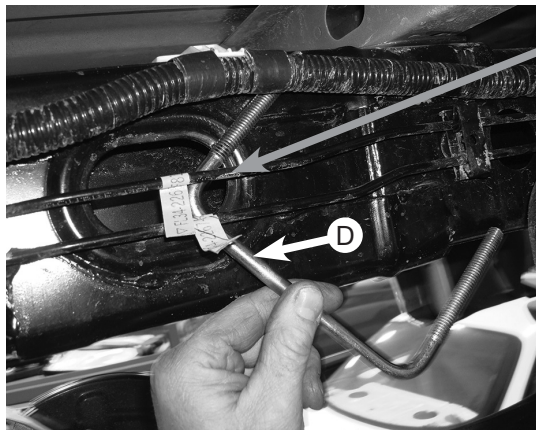

Figure 4 shows U-bolt (D) being installed on the inside of the left (driver-side) frame section on the back side of the jounce bumper mounting location.

fig. 4

Figure 5 shows U-bolt (D) being installed on the inside of the left (driver-side) frame section on the front side of where the jounce bumper is mounted.

fig. 5



CAUTION: DO NOT PINCH THE BRAKE LINES AND WIRING ON THE INSIDE OF THE LEFT (DRIVER SIDE) FRAME. U-BOLTS MUST BE BETWEEN THESE COMPONENTS AND THE FRAME.

fig. 6



Figure 6 shows the U-bolts in the proper location, under the brake lines and wiring on the inside of the left side frame (driver-side).

4. With the U-bolts into position, set the left (A1) and right (A2) upper bracket against the frame while aligning the U-bolts (fig. 7) through the mounting holes in the bracket (fig. 8).



fig. 7

Figure 7 shows the left (driver-side) outside frame with the U-bolts in position.



fig. 8

Figure 8 shows the left (driver-side) outside frame with the upper bracket over the U-bolts and in position.

5. Cap the U-bolts with four 3/8" flat washers (J) and 4 x 3/8" nylon lock nuts (I) (fig. 1). Leave loose at this time.
6. In order to make sufficient clearance for the flex member (the rubber part) on the air spring, it will be necessary to trim the edge of the bracket off on the outside flange of the jounce bumper cup (steel portion). Do this by grinding the flange flush with the rest of the cup (figs. 9 and 10). Spray black paint on the bare metal surface once complete. Repeat for both sides.

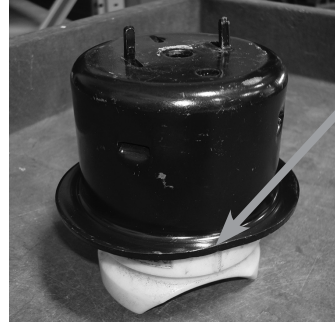

The outside edge of the jounce bumper cup will need to be trimmed here.

fig. 9



The outside edge of the jounce bumper cup showed trimmed. Spray bare surface with black paint.

fig. 10

7. Insert the M-10 tap bolt (G) through a flat washer (J) and then through the jounce bumper (fig. 1). Using the center hole in the bottom flange of the upper bracket, install this assembly back onto the bottom frame flange in the location from which it was removed, making sure the edge that was ground off faces the outside of the vehicle (fig. 11). Tighten the bolt so that the bracket just touches the frame at this time. Do not tighten or torque yet. Repeat for the opposite side.



fig. 11

CAUTION

MAKE ONE LAST CHECK THAT THE U-BOLTS ON THE INSIDE OF THE LEFT FRAME (DRIVER SIDE) ARE NOT PINCHING THE BRAKE LINES OR THE WIRING. ADJUST IF NECESSARY AT THIS POINT.

8. With the upper bracket flush to the bottom frame flange from the last step, torque the frame U-bolts evenly to 10 lb.-ft. (14Nm). Once this is done and the bracket is flush against the frame, torque the jounce bumper bolt to 30 lb.-ft. (41Nm). Repeat for the other side.

ASSEMBLING THE AIR SPRING ASSEMBLY

1. Install the fitting (M) onto the top port of the air spring (C) (fig. 12) finger-tight plus 1-1/2 turns. Repeat for both air springs.

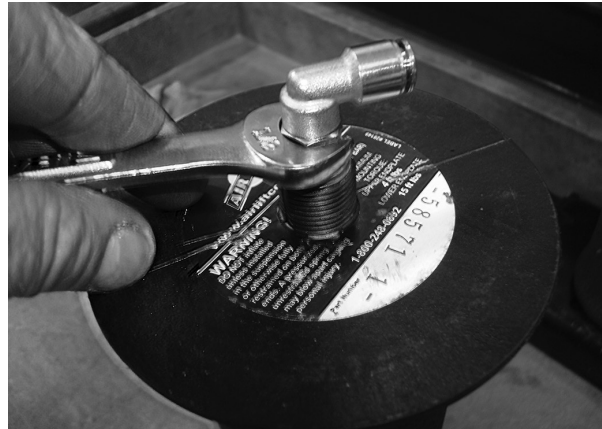
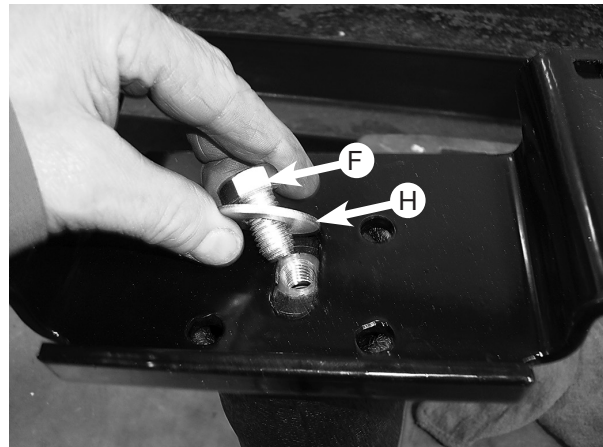

fig. 12

2. Install the air springs (C) to the lower brackets (B) using the 1/2" bolt (F) and flat washer (H) (figs. 1 and 13). Leave loose at this time.



Loosely attach the spring (C) to the lower bracket (B) with the 1/2" bolt (F) and flat washer (H).

fig. 13

3. Set the assemblies onto the leaf spring making sure the upper fitting and thread post on the air spring goes through the slot in the upper bracket. The flange on the lower bracket points to the outside (tire-side) of the vehicle (fig. 14).



Make sure the fitting and thread post go through the slot in the upper bracket.

Make sure the flange on the lower bracket points to the outside (tire-side) of the vehicle.

fig. 14

4. Set the lower bracket U-bolts (E) under the leaf springs and through the holes in the lower bracket (fig. 15) and cap with four 3/8" flat washers (J) and 3/8" nylon lock nuts (I). Torque to finger-tight only at this time.

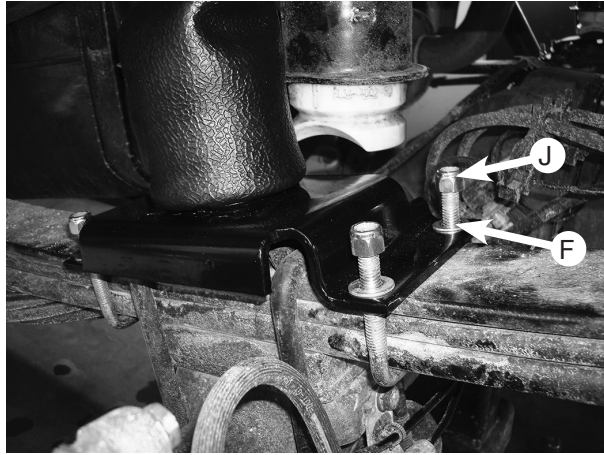
*fig. 15*

Install U-bolts under leaf springs and through the holes in the lower bracket and cap with flat washers (J) and nylon lock nuts (I). Torque to finger-tight only at this time.

5. Install the upper air spring hardware by setting the 3/4" serrated lock washer (K) over the fitting and thread post (fig. 16). Set the 3/4" nylon lock jam nut (L) over the fitting (with the flat side down) and thread onto the post. Torque to finger-tight only at this time.

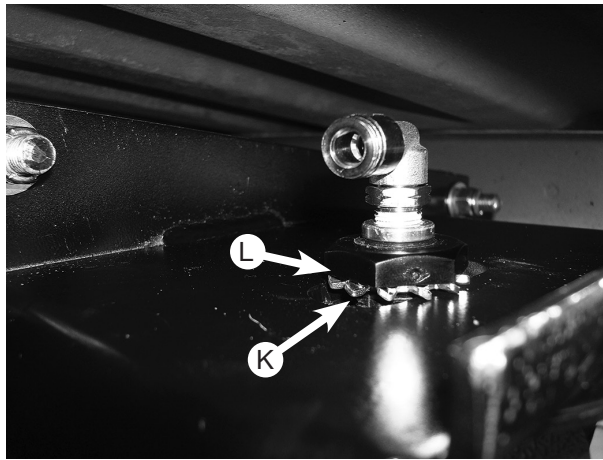
*fig. 16*

Set 3/4" serrated flat washer (K) over fitting and thread post on the air spring. Thread the nylon jam nut (L) onto the thread post. Torque to finger-tight only.

Installing Air Lines

1. Choose a convenient location for mounting the inflation valves. Popular locations for the inflation valve are:
 - a. The wheel well flanges
 - b. The license plate recess in bumper
 - c. Under the gas cap access door
 - d. Through the license plate

NOTE

Whatever the chosen location, make sure there is enough clearance around the inflation valves for an air chuck.

2. Drill two 5/16" holes to install the inflation valves.
3. Cut the air line assembly in two equal lengths.
4. Place a 5/16" nut and star washer on the air valve. Leave enough of the inflation valve in front of the nut to extend through the hole and have room for the rubber washer, flat washer, and 5/16" nut and cap. There should be enough valve exposed after installation – approximately 1/2" – to easily apply a pressure gauge or an air chuck. (Fig. 17.)

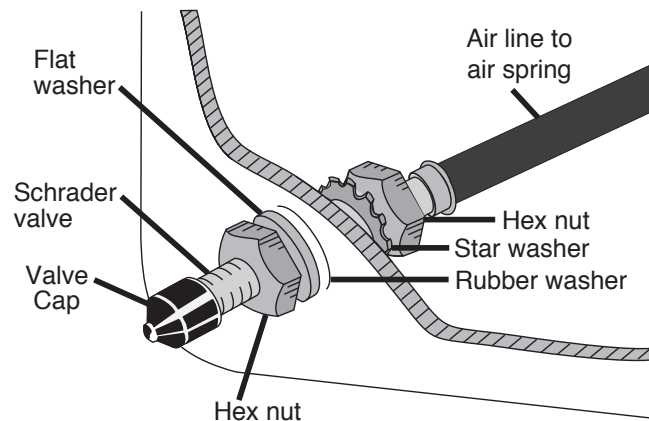

fig. 17

5. Push the inflation valve through the hole and use the rubber washer, flat washer and another 5/16" nut to secure it in place. Tighten the nuts to secure the assembly.
6. Route the air line along the frame to the air fitting on the air spring (Fig. 18). Keep AT LEAST 6" of clearance between the air line and heat sources, such as the exhaust pipes, muffler, or catalytic converter. Avoid sharp bends and edges. Use plastic tie straps to secure the air line to fixed points along the chassis. Be sure that the tie straps are tight, but do not pinch the air line. Leave at least 2" of slack to allow for any movement that might pull on the air line.

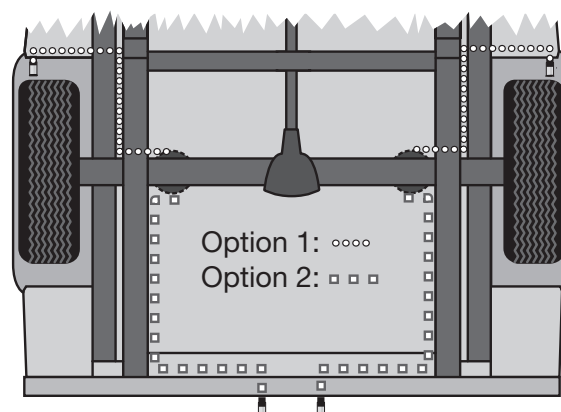

fig. 18

- Cut off the air line, leaving approximately 12" of extra air line. A clean square cut will prevent leaks. Insert the air line into the air fitting. This is a push-to-connect fitting. Simply push the air line into the 90-degree swivel fitting until it bottoms out (9/16" of air line should be in the fitting).

TIPS FOR INSTALLING AIR LINES

When cutting air lines, use a sharp knife or a hose cutter and make clean, square cuts (Fig. 19). Do not use scissors or wire cutters because these tools may deform the air line, causing it to leak around fittings. Do not cut the lines at an angle.

Do not bend the 1/4" hose at a radius of less than 1" or bend the 3/8" hose at a radius of less than 1 1/2". Do not put side load pressure on fitting. The hose should be straight beyond the fitting for 1" before bending.

Inspect hose for scratches that run lengthwise on hose prior to installation. Contact Air Lift customer service at **(800) 248-0892** if the air line is damaged.



Go to air-lift.co/cuttingairline to watch a video demonstrating proper air line cutting.

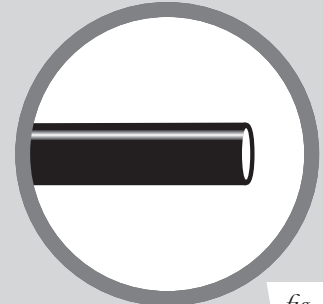
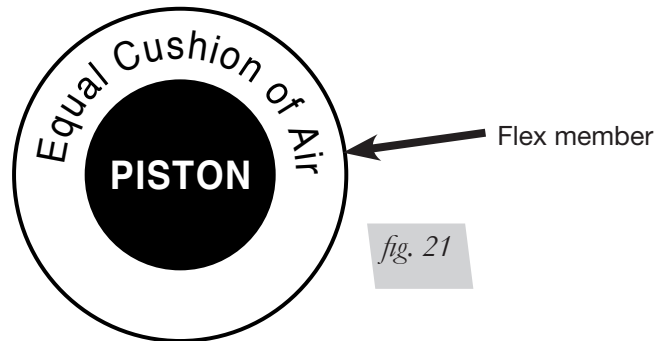

fig. 19



ALIGNING AND FINISHING THE INSTALLATION

1. With the mounting hardware and hose assembly in place, inflate the air spring to 5 PSI (only) at this time.
2. Adjust the spring so that it is perpendicular to both top and bottom brackets by using the slot in the top and bottom mounts. Pinch the flex member at the bottom around the piston (figs. 20 and 21). There should be a symmetrical cushion of air around the flex member and piston.

fig. 20

fig. 21

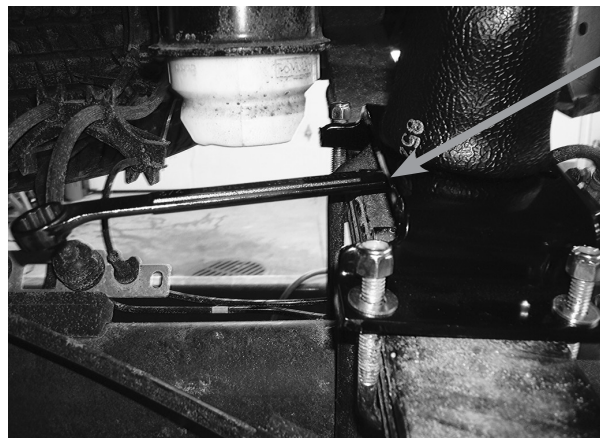
3. You will need to adjust and tighten the bottom of the air spring first. In order to do this, mark the location of the bottom piston in reference to the lower bracket. Deflate the air pressure from the air spring and raise the inside of the lower bracket up enough to slip a 3/4" open end wrench onto the 1/2" bolt, which is attaching the spring to the lower mount (fig. 22). Tighten the bolt no more than 15 lb.-ft. (20Nm). Repeat for the opposite side.



Raise the inside of the lower bracket up enough to slip a 3/4" wrench over the 1/2" bolt and torque to no more than 15 lb.-ft. (20Nm).

fig. 22

- Once the lower is set, inflate the air springs back to 5 PSI and, if necessary, readjust the upper spring forward or back in the slot. Using a medium adjustable wrench or an open end wrench, tighten the nylon jam nut to no more than 4 lb.-ft. (5Nm) (just snug) (fig. 23). Repeat for the other side.

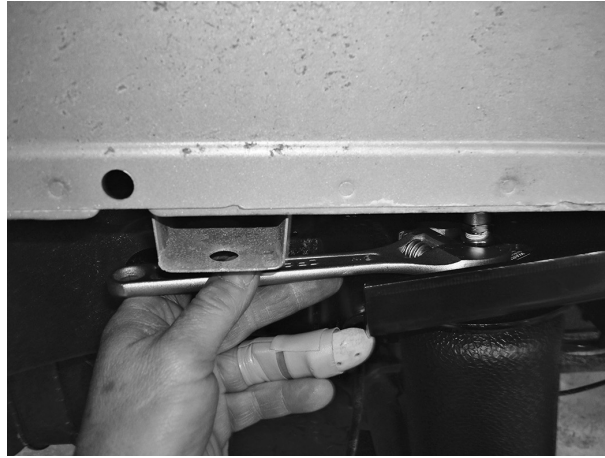

Adjust air spring and torque to no more than 4 lb.-ft. (5Nm). using a medium size adjustable size wrench or open end wrench.

fig. 23

- Once the air spring has been properly aligned, torque the lower mounting hardware on the lower bracket U-bolts to 15 lb.-ft. (20Nm). on both sides.
- Figures 24 and 25 show the left- and right-hand assemblies installed on the vehicle.



Back, side view of left side (driver-side) installation shown.

fig. 24

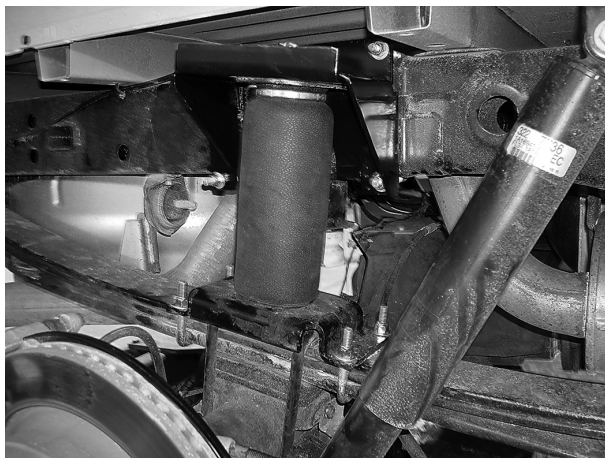

Forward, side view of right-side (passenger-side) installation shown.

fig. 25

- Install the tires back onto the vehicle and torque to the manufacturers torque specifications.

Before Operating

CHECKING FOR LEAKS

1. Inflate the air spring to 30 PSI.
2. Spray all connections and the inflation valves with a solution of 1/5 liquid dish soap and 4/5 water. Spot leaks easily by looking for bubbles in the soapy water.
3. After the test, deflate the springs to the minimum pressure required to restore the system to normal ride height. Do not deflate to lower than 5 PSI.
4. Check the air pressure again after 24 hours. A 2-4 PSI loss after initial installation is normal. Retest for leaks if the loss is more than 5 PSI.

FIXING LEAKS

1. If there is a problem with the swivel fitting:
 - a. Check the air line connection by deflating the spring and removing the line by pulling the collar against the fitting and pulling firmly on the air line. Trim 1" off the end of the air line. Be sure the cut is clean and square (see Fig. b). Reinsert the air line into the push-to-connect fitting.
 - b. Check the threaded connection by tightening the swivel fitting another half turn. If it still leaks, deflate the air spring, remove the fitting, and re-coat the threads with thread sealant. Reinstall by hand tightening as much as possible and then use a wrench for an additional two turns.
2. If there is a problem with the inflation valve:
 - a. Check the valve core by tightening it with a valve core tool.
 - b. Check the air line by removing the air line from the barbed type fitting. Cut the air line off a few inches in front of the fitting and use a pair of pliers or vice grips to pull/twist the air line off of the fitting.



CAUTION

DO NOT CUT OFF THE AIR LINE COMPLETELY AS THIS WILL USUALLY NICK THE BARB AND RENDER THE FITTING USELESS.

3. If the preceding steps have not resolved the problem, call Air Lift customer service at **(800) 248-0892**.

INSTALLATION CHECKLIST

- Clearance test** — Inflate the air springs to 75-90 PSI and make sure there is at least 1/2" clearance from anything that might rub against each sleeve. Be sure to check the tire, brakes, frame, shock absorbers and brake cables.
- Leak test before road test** — Inflate the air springs to 75-90 PSI and check all connections for leaks. All leaks must be eliminated before the vehicle is road tested.
- Heat test** — Be sure there is sufficient clearance from heat sources, at least 6" for air springs and air lines. If a heat shield was included in the kit, install it. If there is no heat shield, but one is required, call Air Lift customer service at (800) 248-0892.
- Fastener test** — Recheck all bolts for proper torque.
- Road test** — The vehicle should be road tested after the preceding tests. Inflate the springs to recommended driving pressures. Drive the vehicle 10 miles and recheck for clearance, loose fasteners and air leaks.
- Operating instructions** — If professionally installed, the installer should review the operating instructions with the owner. Be sure to provide the owner with all of the paperwork that came with the kit.

POST-INSTALLATION CHECKLIST

- Overnight leak down test** — Recheck air pressure after the vehicle has been used for 24 hours. If the pressure has dropped more than 5 PSI, then there is a leak that must be fixed. Either fix the leak yourself or return to the installer for service.
- Air pressure requirements** — It is important to understand the air pressure requirements of the air spring system. Regardless of load, the air pressure should always be adjusted to maintain adequate ride height at all times while driving.
- Thirty-day or 500-mile test** — Recheck the air spring system after 30 days or 500 miles, whichever comes first. If any part shows signs of rubbing or abrasion, the source should be identified and moved, if possible. If it is not possible to relocate the cause of the abrasion, the air spring may need to be remounted. If professionally installed, the installer should be consulted. Check all fasteners for tightness.

Product Use, Maintenance and Servicing

Minimum Recommended Pressure	Maximum Air Pressure
5 PSI	100 PSI

NOTE

BY FOLLOWING THE STEPS BELOW, VEHICLE OWNERS WILL OBTAIN THE LONGEST LIFE AND BEST RESULTS FROM THEIR AIR SPRINGS.

1. Check air pressure weekly.
2. Always maintain normal ride height. Never inflate beyond 100 PSI.
3. If you develop an air leak in the system, use a soapy water solution (1/5 liquid dish soap and 4/5 water) to check all air line connections and the inflation valve core before deflating and removing the air spring.

CAUTION

FOR SAFETY AND TO PREVENT POSSIBLE DAMAGE TO THE VEHICLE, DO NOT EXCEED MAXIMUM GROSS VEHICLE WEIGHT RATING (GVWR), AS INDICATED BY THE VEHICLE MANUFACTURER. ALTHOUGH THE AIR SPRINGS ARE RATED AT A MAXIMUM INFLATION PRESSURE OF 100 PSI, THE AIR PRESSURE ACTUALLY NEEDED IS DEPENDENT ON LOAD AND GVWR.

4. Loaded vehicles require at least 25 PSI. A “loaded vehicle” refers to a vehicle with a heavy bed load, a trailer or both. Never exceed GVWR, regardless of air spring, air pressure or other load assist. The springs in this kit will support approximately 40 pounds of load (combined on both springs) for each 1 PSI of pressure. The required air pressure will vary depending on the state of the original suspension. Operating the vehicle below the minimum air spring pressure will void the Air Lift warranty.
5. When increasing load, always adjust air pressure to maintain normal ride height. Increase or decrease pressure from the system as necessary to attain normal ride height for optimal ride and handling. Remember that loads carried behind the axle (including tongue loads) require more leveling force (pressure) than those carried directly over the axle.
6. Always add air to springs in small quantities, checking the pressure frequently.
7. Should it become necessary to raise the vehicle by the frame, make sure the system is at minimum pressure (5 PSI) to reduce the tension on the suspension/ brake components. Use of on-board leveling systems do not require deflation or disconnection.
8. Periodically check the air spring system fasteners for tightness. Also, check the air springs for any signs of rubbing. Realign if necessary.
9. On occasion, give the air springs a hard spray with a garden hose to remove mud, sand, gravel or other debris.

TUNING THE AIR PRESSURE

Pressure determination comes down to three things — level vehicle, ride comfort and stability.

1. Level vehicle

If the vehicle's headlights are shining into the trees or the vehicle is leaning to one side, then it is not level (Fig. 26). Raise the air pressure to correct either of these problems and level the vehicle.

2. Ride comfort

If the vehicle has a rough or harsh ride it may be due to either too much pressure or not enough (Fig. 27). Try different pressures to determine the best ride comfort.

3. Stability

Stability translates into safety and should be the priority, meaning the driver may need to sacrifice a perfectly level and comfortable ride. Stability issues include roll control, bounce, dive during braking and sponginess (Fig. 28). Tuning out these problems usually requires an increase in pressure.

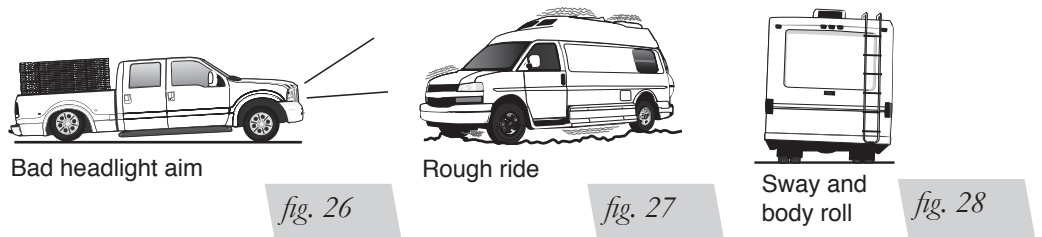

Guidelines for Adding Air

1. Start with the vehicle level or slightly above.
2. When in doubt, always add air.
3. If the front of the vehicle dives while braking, increase the pressure in the front air bags, if equipped.
4. If it is ever suspected that the air bags have bottomed out, increase the pressure. (Fig. 29)
5. Adjust the pressure up and down to find the best ride.
6. If the vehicle rocks and rolls, adjust the air pressure to reduce movement.
7. It may be necessary to maintain different pressures on each side of the vehicle. Loads such as water, fuel, and appliances will cause the vehicle to be heavier on one side (Fig. 30). As much as a 50 PSI difference is not uncommon.

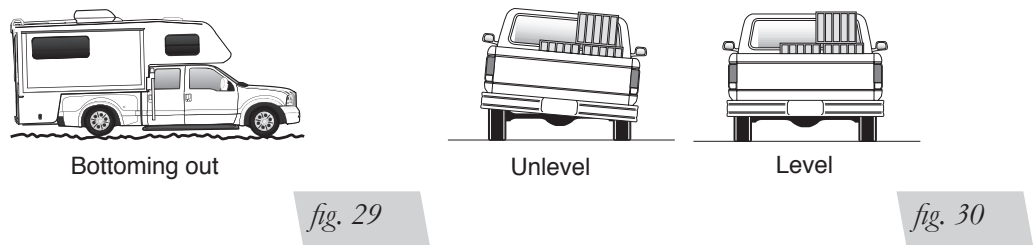

Frequently Asked Questions

Q. The system won't maintain pressure overnight. What could be wrong?

One of the air lines may be improperly installed or a line may have a hole or crack. Start by leak testing the air line connections. If no leaks are found, look for leaks in the rest of the air lines. Follow the steps in "Fixing Leaks."

Q. One of the corners won't rise.

Look for a kink or fold in the air line going to that air spring. Replace any line that has been kinked.

Q. Will installing air springs increase the weight ratings of a vehicle?

No. Adding air springs will not change the weight ratings (GAWR, GCWR and/or GVWR) of a vehicle. Exceeding the GVWR is dangerous and voids the Air Lift warranty.

Q. Is it necessary to keep air in the air springs at all times and how much pressure will they need?

For LoadLifter 5000 Ultimate, the recommended minimum air pressure is 5 PSI, but it can safely be run at zero air pressure.

Q. Is it necessary to add a compressor system to the air springs?

No. Air pressure can be adjusted with any type of compressor as long as it can produce sufficient pressure to service the springs. Even a bicycle tire pump can be used, but it's a lot of work.

Q. How long should air springs last?

If the air springs are properly installed and maintained they can last indefinitely.

Q. Will raising the vehicle on a hoist for service work damage the air springs?

No. The vehicle can be lifted on a hoist for short-term service work such as tire rotation or oil changes. However, if the vehicle will be on the hoist for a prolonged period of time, support the axle with jack stands in order to take the tension off of the air springs.



Notes

Notes

Limited Warranty and Return Policy

Air Lift Company provides a limited lifetime warranty to the original purchaser of its Load Support products, that the products will be free from defects in workmanship and materials when used on cars and trucks as specified by Air Lift Company and under normal operating conditions, subject to the requirements and exclusions set forth in the full Limited Warranty and Return Policy that is available online at www.airliftcompany.com/warranty.

For additional warranty information contact Air Lift Company customer service.

Replacement Part Information

If replacement parts are needed, contact the local dealer or call Air Lift customer service at **(800) 248-0892**. Most parts are immediately available and can be shipped the same day.

Contact Air Lift Company customer service at (800) 248-0892 first if:

- Parts are missing from the kit.
- Need technical assistance on installation or operation.
- Broken or defective parts in the kit.
- Wrong parts in the kit.
- Have a warranty claim or question.

Contact the retailer where the kit was purchased:

- If it is necessary to return or exchange the kit for any reason.
- If there is a problem with shipping if shipped from the retailer.
- If there is a problem with the price.

Contact Information

Mailing address	P.O. Box 80167 Lansing, MI 48908-0167
Shipping address for returns	2727 Snow Road Lansing, MI 48917
Phone	Toll free: (800) 248-0892 International: (517) 322-2144
Email	service@airliftcompany.com
Web address	www.airliftcompany.com

Need Help?

Contact Air Lift Company customer service department by calling (800) 248-0892.

For calls from outside the USA or Canada, dial (517) 322-2144.



Thank you for purchasing Air Lift products — the professional installer's choice!

Air Lift Company • 2727 Snow Road • Lansing, MI 48917 or P.O. Box 80167 • Lansing, MI 48908-0167
Toll Free (800) 248-0892 • Local (517) 322-2144 • Fax (517) 322-0240 • www.airliftcompany.com

Printed in the USA
JPR-0417