

# Owner's Manual with Installation Instructions

## **Banks Six-Gun® Diesel Tuner**

**Compatible with Optional Banks PowerPDA®**

*For use with Palm® Tungsten™ E2 only*

**2007- 2010 Chevy/GMC 6.6L (LMM) Duramax  
Turbo-Diesel Pickups**

THIS MANUAL IS FOR USE WITH KITS 63887 & 63892

Gale Banks Engineering  
546 Duggan Avenue • Azusa, CA 91702  
(626) 969-9600 • Fax (626) 334-1743

Product Information & Sales: (888) 635-4565  
Customer Support: (888) 839-5600  
Installation Support: (888) 839-2700

**bankspower.com**



**THIS IS A HIGH PERFORMANCE PRODUCT. USE AT YOUR OWN RISK.**

**Do not use this product until you have carefully read the following agreement.**

**This sets forth the terms and conditions for the use of this product. The installation of this product indicates that the BUYER has read and understands this agreement and accepts it's terms and conditions.**

## Disclaimer of Liability

Gale Banks Engineering Inc., and it's distributors, employees, and dealers (hereafter "**SELLER**") shall in no way be responsible for the product's proper use and service. The **BUYER** hereby waives all liability claims.

The **BUYER** acknowledges that he/she is not relying on the **SELLER'S** skill or judgment to select or furnish goods suitable for any particular purpose and that there are no liabilities which extended beyond the description on the face hereof and the **BUYER** hereby waives all remedies or liabilities, expressed or implied, arising by law or otherwise, (including without any obligations of the **SELLER** with respect to fitness, merchantability, and consequential damages) whether or not occasioned by the **SELLER'S** negligence.

The **BUYER** is responsible to fully understand the capability and limitations of his/her vehicle according to manufacturer specifications and agrees to hold the **SELLER** harmless from any damage resulting from the failure to adhere to such specifications. The **SELLER** disclaims any warranty and expressly disclaims any liability for personal injury or damages. The **BUYER** acknowledges and agrees

that the disclaimer of any liability for personal injury is a material term for this agreement and the **BUYER** agrees to indemnify the **SELLER** and to hold the **SELLER** harmless from any claim related to the item of the equipment purchased. Under no circumstances will the **SELLER** be liable for any damages or expenses by reason of the use or sale of any such equipment. The **BUYER** is responsible to obey all applicable federal, state, and local laws, statutes, and ordinances when operating his/her vehicle, and the **BUYER** agrees to hold **SELLER** harmless from any violation thereof. The **SELLER** assumes no liability regarding the improper installation or misapplication of it's products. It is the installer's responsibility to check for proper installation and if in doubt, contact the manufacturer. The **BUYER** is solely responsible for all warranty issues from the automotive manufacturer.

## Limitation of Warranty

Gale Banks Engineering Inc. (hereafter "**SELLER**"), gives Limited Warranty as to description, quality, merchantability, fitness for any particular purpose, productiveness, or any other matter of **SELLER'S** product sold herewith. The **SELLER** shall be in no way responsible for the product's open use and service and the **BUYER** hereby waives all rights except those expressly written herein. This warranty shall not be extended or varied except by written instrument signed by **SELLER** and **BUYER**.

Please see enclosed warranty information card, or go to **www.bankspower.com/warranty**, for warranty information regarding your product. Parts or devices outside the products kit, such as the Palm® Tungsten™ E2, are not covered under Gale Banks Engineering warranty. The warranty for the Palm Tungsten E2 is determined by the manufacturer's warranty terms and conditions, and

limited to a period of 90 days from purchase. All products that are in question of warranty must be returned shipping prepaid to the **SELLER** and must be accompanied by a dated proof of purchase receipt. All warranty claims are subject to approval by Gale Banks Engineering Inc.

**WARNING:** The PDA may be susceptible to damage as a result of extended exposure to sunlight, heat or extreme cold. It is highly recommended that the PDA be removed from it's mounting location if the vehicle will be subjected to high concentrations of sunlight, heat or cold for an extended period of time. Gale Banks Engineering is not responsible for damage to PDAs resulting from exposure conditions.

Under no circumstance shall the **SELLER** be liable for any labor charged or travel time incurred in diagnosis for defects, removal, or reinstallation of this product, or any other contingent expense.

Under no circumstances will the **SELLER** be liable for any damage or expenses incurred by reason of the use or sale of any such equipment.

**In the event that the buyer does not agree with this agreement:**

The buyer may promptly return this product, in a new and unused condition, with a dated proof-of-purchase, to the place-of-purchase within thirty (30) days from date-of-purchase for a full refund, less shipping and/or restocking fee.

The installation of this product indicates that the buyer has read and understands this agreement and accepts it's terms and conditions.

## Table of Contents

<b>Introduction</b> .....	<b>4</b>
<b>General Installation Practices</b> ....	<b>5</b>
<b>Section 1</b> .....	<b>7</b>
Installation of Wiring Harness, Connections and Six-Gun Diesel Tuner	
<b>Section 2</b> .....	<b>11</b>
Mounting the (optional) Docking Station and Connecting the Banks PowerPDA	
<b>Section 3</b> .....	<b>14</b>
Installation of the (optional) Six-Gun Selector Switch	
<b>Section 4</b> .....	<b>19</b>
Optional Thermocouple Installation (Required for optional Banks PowerPDA)	
<b>Section 5</b> .....	<b>20</b>
Automatic Transmission Learning	
<b>Section 6</b> .....	<b>21</b>
Checking Engine Performance	
<b>Section 7</b> .....	<b>22</b>
Troubleshooting	
<b>Section 8</b> .....	<b>25</b>
Clearing Learned Information	
<b>Section 9</b> .....	<b>26</b>
Removal of the Six-Gun Diesel Tuner	
<b>Section 10</b> .....	<b>29</b>
Placement of the Banks Power Decals	

# Introduction

**Dear Customer,**

**If you have any questions concerning the installation of your Banks Six-Gun Diesel Tuner, please call our Technical Service Hotline at (888) 839-2700 between 7:00am and 5:00pm (PST). If you have any questions relating to shipping or billing, please contact our Customer Service Department at (888) 839-5600.**

**Thank you.**

The Banks Six-Gun Diesel Tuner has six power levels adjustable by the supplied Six-Gun Switch.

The optional Banks PowerPDA is a versatile touch-screen interface to the Six-Gun Tuner and your truck that also increases the Six-Gun's power output. With the push of a button, you can change power levels on-the-fly. It displays four engine functions at a time, two of which are user-selectable (over a dozen to choose from). It will clock your 0-60 mph, 1/8-mile and 1/4-mile performance runs, recording peak boost and EGT values. Performance runs are automatically stored for later retrieval with a time-and-date stamp. With the Banks PowerPDA, you can also scan and clear OBD II diagnostic codes. It gives you the endless functionality of a Palm® Tungsten™ E2 PDA, and fits in a custom docking station using infrared wireless connectivity.

The Six-Gun Diesel Tuner comes with a Six-Gun Switch that has six selectable power levels. The Six-Gun Switch is

included in the Six-Gun Diesel Tuner. Level 1 is stock. Each additional higher level adds approximately 20% of the available power increase.

To prevent damage to the factory transmission, Banks recommends that automatic transmission vehicles do not exceed Level 4 with PowerPDA while the vehicle is experiencing load (towing, climbing a steep grade, carrying a load, etc.).

To use the higher levels of the Six-Gun Diesel Tuner while towing or climbing, airflow and exhaust improvements must be made to lower the exhaust gas temperature (EGT) entering the turbo. The EGT should not exceed 1400° F for more than a few seconds. Elevated EGTS can damage the turbocharger and the engine.

**ATTENTION!** Before proceeding with these instructions, please carefully read the DISCLAIMER OF LIABILITY and LIMITATION OF WARRANTY statement located on page 2 of this manual.

**WARNING: The PDA may be susceptible to damage as a result of extended exposure to sunlight, heat or extreme cold. It is highly recommended that the PDA be removed from its mounting location if the vehicle will be subjected to high concentrations of sunlight, heat or cold for an extended period of time. Gale Banks Engineering is not responsible for damage to PDAs resulting from exposure conditions.**

# General Installation Practices

## TOOLS REQUIRED:

- Inch and metric sockets
- Inch and metric combination and open-end wrenches
- Pliers
- Wire cutters or scissors
- Center punch
- Drill or 90° drill
- 1/8" drill bit
- 3/8" Uni-bit step drill bit or 3/8" drill bit
- R drill bit (0.339")  
(A 5/16" drill bit (0.313") may be used if an R drill bit cannot be found)
- 1/8" NPT (National Pipe Thread) tap
- Torque wrench
- Penetrating oil or light lubricant spray
- Anti-seize compound

**1.** Before starting work, familiarize yourself with the installation procedure by reading all of the instructions.

**2.** The exploded views provide only general guidance. Refer to each step and section diagram in this manual for proper instruction.

**3.** Throughout this manual, the left side of the vehicle refers to the driver side, and the right side to the passenger side.

**4.** Disconnect the negative (ground) cable from the battery (or batteries, if there are two) before beginning work.

**5.** Route and tie wires and hoses a minimum of 6" away from exhaust heat, moving parts and sharp edges. Clearance of 8" or more is recommended where possible.

**6.** When raising the vehicle, support it on properly weight-rated safety stands, ramps or a commercial hoist.

Follow the manufacturer's safety precautions. Take care to balance the vehicle to prevent it from slipping or falling. When using ramps, be sure the

front wheels are centered squarely on the topsides. When raising the front of the vehicle, put the transmission in park (automatic) or reverse (manual), set the parking brake, and block the rear wheels. When raising the back of the vehicle, be sure the vehicle is on level ground and the front wheels are blocked securely.

**CAUTION: Do not use floor jacks to support the vehicle while working under it. Do not raise the vehicle onto concrete blocks, masonry or any other item not intended specifically for this use.**

**7.** During installation, keep the work area clean. Do not allow anything to be dropped into intake, exhaust, or lubrication system components while performing the installation, as foreign objects will cause immediate engine damage upon start-up.

**8.** Save this Owner's Manual as a reference for system maintenance and service.

**9.** If you purchased the Banks PowerPDA®, then the Palm Tungsten E2 will need to be charged for a minimum of 1-2 hours before the Banks software can be installed. Locate the supplied AC outlet wall charger, also located in your kit and plug the charging cord into the Tungsten E2. Please refer to the Banks PowerPDA Software & Installation Kit Owner's Manual for additional instruction.

**10.** Banks recommends either a Banks PowerPDA or a Pyrometer (EGT) gauge and Boost gauge be installed with the Six-Gun Diesel Tuner to help monitor performance and exhaust gas temperature of the vehicle. To further increase engine life by lower EGT's, Banks also recommends installing a Ram-Air and Monster Exhaust® system.

Description	Part Number	Kit	
		63892	63887
Module, Six-Gun Diesel Tuner	63886	1	1
Switch Kit	62139		1
Cable Ties, 7"	62010	15	20
PowerPDA Docking Station Kit	63878	1	
SD Card, 64 MB, Programmed	61007	1	
Universal Mount Kit	61009	1	
OBD-II Interface Cable	62599	1	
Thermocouple	63057	1	
Cable Tie, 5"	62001	5	
Cable Tie, 11"	62002	1	

<b>Optional</b>	<b>Part Number</b>
Palm Tungsten E2 PDA	61004
Gauges, Boost and Pyro*	64507

# Section 1

## INSTALLATION OF WIRING HARNESS, CONNECTIONS AND SIX-GUN DIESEL TUNER

**Figure 1** Six-Gun Tuner and supplied wiring harness

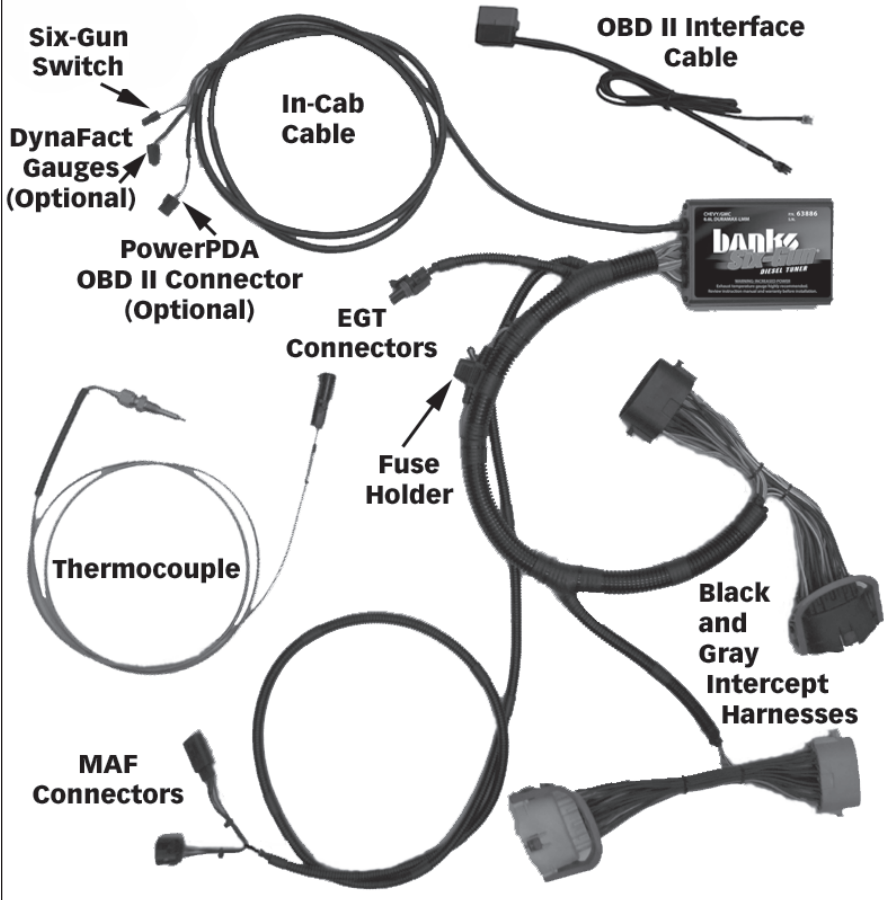

**1.** Disconnect the battery ground cables from each of the batteries. Secure the cables so that they do not come in contact with the battery posts during the installation.

**2.** Place the Banks Six-Gun Tuner on top of the fuse box cover. Direct the wire harness towards the rear of the vehicle as shown in **Figure 2**.

*NOTE: Do not attach the Tuner at this time.*

**3.** Locate the black and gray wire harness locking connectors between the brake fluid reservoir and the air conditioning compressor. Slide the green locking tabs back and lift the blue connector locks to disconnect the connector pairs. See **Figure 3**.

**Figure 2**



*NOTES: A small screwdriver may help in lifting the blue connector locks. Take care not to break the plastic on the connectors.*

*It may be necessary to open the wire harness retainer clip(s) with a screwdriver for added slack when joining the connectors together.*

**4.** Insert the male gray connector on the Six-Gun harness into the female gray connector on the factory harness. Insert the female gray connector on the Six-Gun harness onto the male gray connector of the factory harness. Repeat this process with the black connectors. See **Figure 3**.

**5.** Go to the air box and remove the stock mass air flow (MAF) connector located on the elbow of the air box cover and set aside.

**6.** Locate the MAF connector from the Six-Gun Tuner harness and route as shown in **Figure 4**. Follow the factory harness located on top of the engine that runs in front of the intake manifold and behind the alternator.

**7.** Connect the Six-Gun Tuner's (female) MAF connector to the factory (male) MAF sensor and connect the factory (female) MAF connector to the Six-Gun's (male) MAF connector.

**8.** Locate the rubber grommet on the driver's side of the vehicle firewall. The grommet is about 3" in diameter. Make a 1" x 1" cross-shaped (X) incision in the grommet. Be careful so you do not cut the factory harness.

**9.** From inside the cab locate the grommet on the firewall and make another 1" x 1" cross-shaped (X) incision on the grommet, opposite the



**Figure 3**

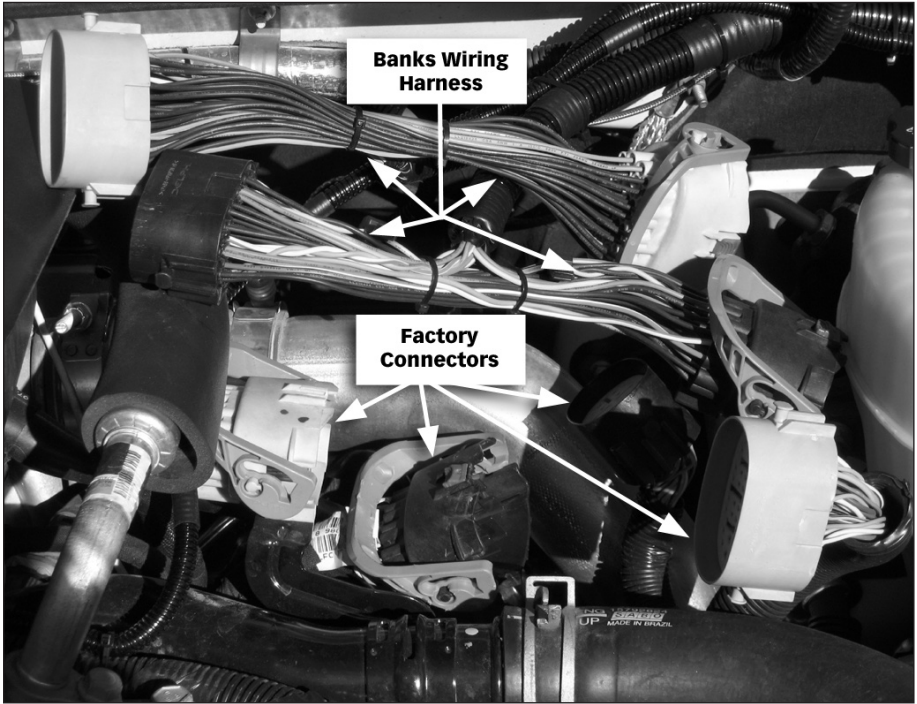

spot that was cut from the outside. Now, feed the In-Cab cable through the incision made in the firewall grommet and into the cab (**Figure 5**).

*NOTE: Some thick putty may be used to provide additional sealing around the In-Cab cable and the grommet.*

**Figure 4**

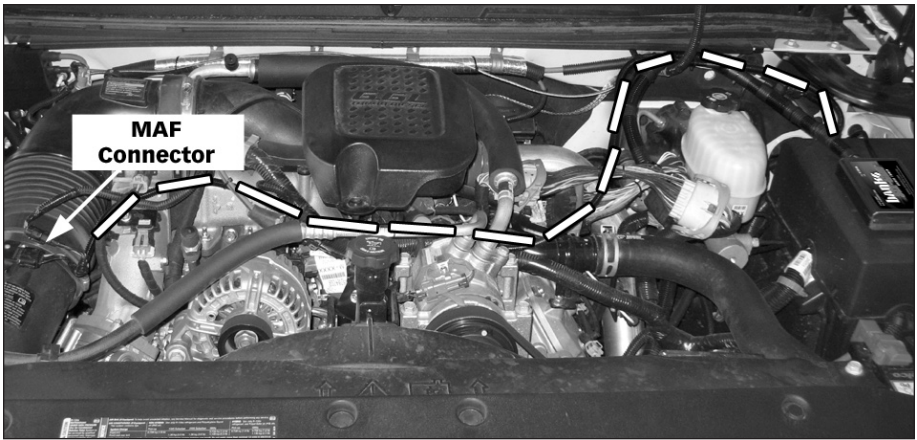

**Figure 5**

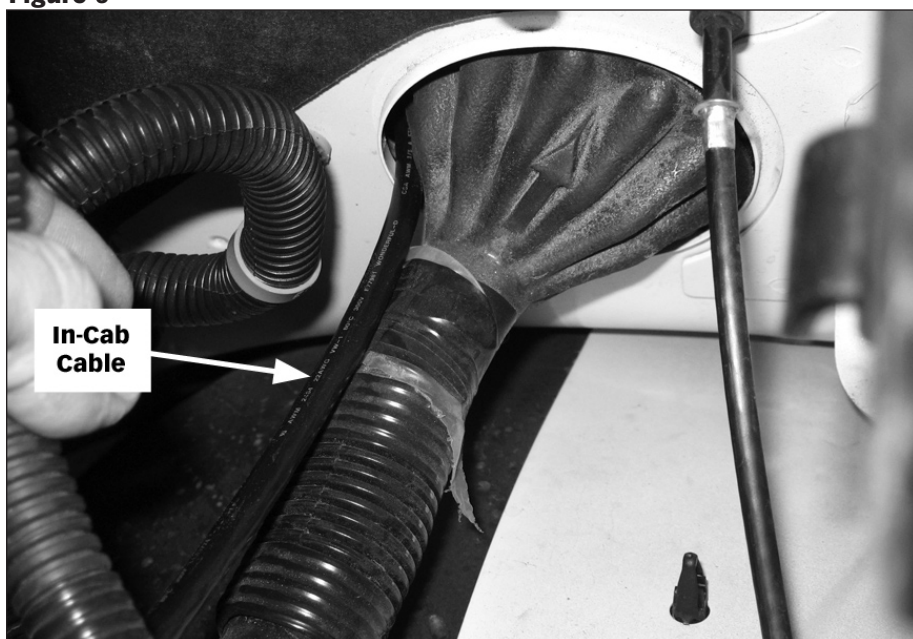

**10.** Position the Tuner on the fuse box cover for an idea of where to clean. The Tuner must be mounted as close to the inside (engine side) edge as possible to avoid a hood clearance issue. Check the hood clearance before attaching the Tuner to the fuse box. Clean the top of the fuse box cover located on the drivers' side of the engine compartment. Make sure the outside of the fuse box is free of oil, grease and dirt.

*NOTE: Clean the fuse box cover with a non-oil based solvent such as Acetone, Mineral Spirits, Denatured Alcohol or Lacquer Thinner. Read and follow the manufacture's operation instruction for non-oil based solvent cleaner.*

**WARNING: Make sure to place the Tuner as shown in Figure 2 to avoid a clearance issue when closing the hood. Mount the Six-Gun Tuner as close to the inside (engine side) edge of the fuse cover as possible.**

**Verify you have hood clearance before mounting the Tuner.**

**11.** Peel the protective backing from the hook and loop interlocking fasteners attached to the Six-Gun Diesel Tuner. Position the side edge of the Six-Gun Diesel Tuner to the edge closest to the engine of the fuse cover, then press the adhesive onto the outside of the fuse box cover. Apply light pressure to the Six-Gun Diesel Tuner by hand for 60-seconds to create a strong bond between the fuse box and hook & loop interlocking fasteners. Using the supplied cable ties, secure the wire harness away from any heat sources or moving components.

**CAUTION: When securing the wires, do not bend them any tighter than a 2.5" diameter bend as this can cause undue stress on the wires and may cause failure.**

-END, SECTION 1-

## Section 2

### MOUNTING THE (OPTIONAL) DOCKING STATION AND CONNECTING THE BANKS POWERPDA

If not installing the optional Banks PowerPDA, skip to **Section 3**.

**1.** Locate the universal mount and docking station in your kit. Interlock the docking station to the universal mount by inserting and sliding the universal mount tabs into the docking station grooves. See **Figure 6**.

**2.** Install the Banks PowerPDA into the docking station. Be sure the PowerPDA is completely seated in the docking station against the lower support bracket.

*NOTE: There may be a snug fit when installing the PowerPDA into the docking station. Take care not to force this process.*

**3.** Find a smooth, flat surface suitable for ease of access and viewing of the PowerPDA. See **Figure 7** for an example. Loosen both knobs and move the swivel suction plate and docking station to achieve desired viewing angle of the PowerPDA screen. Do a test fit and note the angle necessary to achieve the correct viewing angle.

**3.** Tighten both knobs to lock in the position (**Figure 6**).

*NOTE: If the universal mount swivel does not move or is tight after loosening the hold down knob, then remove the previously inserted docking station and slightly loosen the tension screw. See **Figure 8**.*

**4.** With the alcohol swab from your kit, clean the suction cup and the mounting area and let dry. With the suction lever in the up position ensure the suction cup is flat against the windshield or smooth, flat surface. Then, push the suction lever down to secure in place.

**5.** Find the Banks OBD II Interface Cable in your kit. Connect the Banks Interface Cable to the vehicle's OBD II connector. Use a cable tie as shown in **Figure 9** to secure the Banks Interface Cable to the vehicle's OBD II connector.

**6.** Next, connect the 6-terminal connector on the Banks OBD II Interface Cable to the 6-pin connector on the Six-Gun Tuner harness.

**Figure 6**

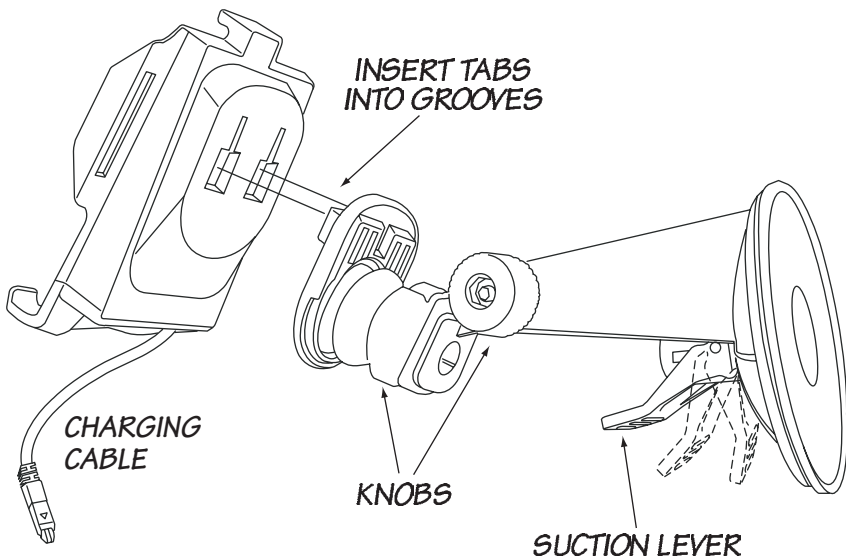

**Figure 7**



**Figure 8**

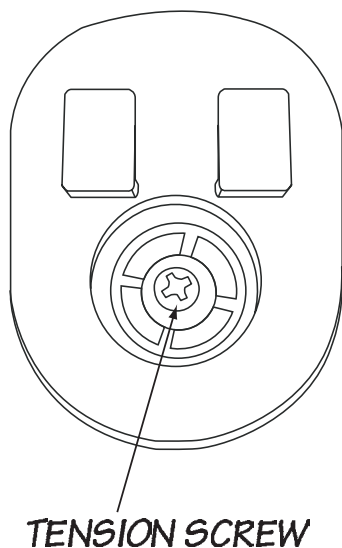

**7.** For the cleanest PowerPDA installation (**Figure 7**), remove the fuse access panel by pulling it out from the side of the dash. Route the RJ12 connector (phone like connector) on the Banks OBD II Interface Cable under the dash and out where the fuse access panel was. The RJ12 connectors's cable can be slid under the door frame's seal and run up to the top of the dash. Plug the RJ12 connector into one of the receptacles in the base of the PDA docking station. Re-install the fuse access panel.

**8.** Plug the docking station's charging cable (seen in **Figure 6**) into the charging receptacle on the lower edge of the PowerPDA.

**WARNING: The charging cable on the docking station is designed to supply a constant low-voltage power source (+5vdc) to the Banks PowerPDA and is "live" as long as the system's OBD II Interface Cable is completely installed and the RJ12 connector is plugged into the docking station. Although this charging cable is short and it's circuitry**

**Figure 9**

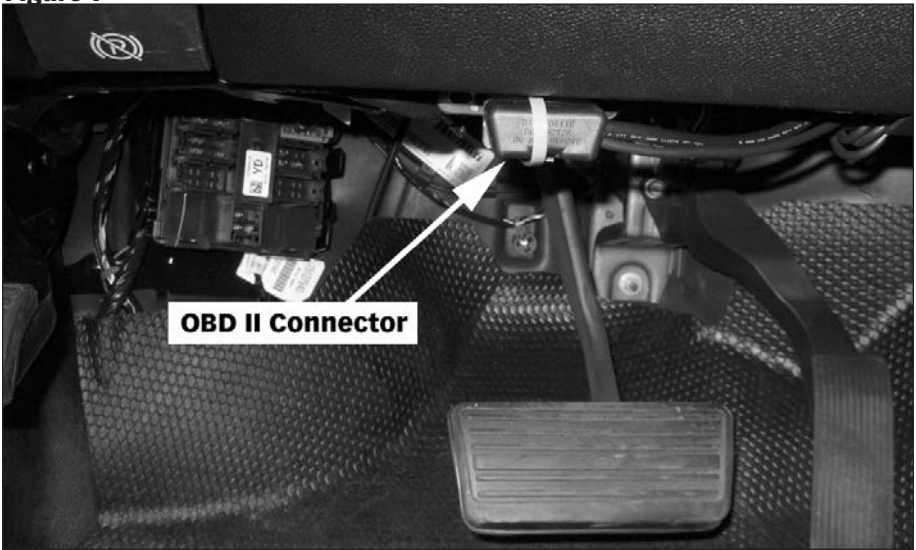

**is fuse protected, the user is expected to take appropriate measures to prevent small children and/or pets from contact with any part of this system.**

**9.** Route all wiring away from any pedals or other moving components. Using the cable ties supplied, secure the wiring under the dash.

**10.** Double check everything to make sure it is securely fastened and it is not near any hot or moving parts before starting engine.

**11.** Set up the Banks PowerPDA according to it's instructions.

**12.** Re-connect the negative (ground) cable(s).

**WARNING:** The PDA may be susceptible to damage as a result of extended exposure to sunlight, heat or extreme cold. It is highly recommended that the PDA be removed from it's mounting location if the vehicle will be subjected to high concentrations of sunlight, heat or cold for an extended period of time. Gale Banks Engineering is not responsible for damage to PDA's resulting from exposure conditions.

-END SECTION 2-

# Section 3

## INSTALLATION OF THE (OPTIONAL) SIX-GUN SELECTOR SWITCH

Not needed if the optional Banks PowerPDA is installed.

**CAUTION: Do not use force when working on plastic parts. Permanent damage to the part may result.**

*NOTE: Before drilling, confirm that there is adequate room for the Switch and wires behind the dash. Make sure wires or obstructions are cleared from the drilling area.*

*From where the Six-Gun Switch will be located, make sure there is enough wire on the In-Cab Cable to reach the Switch.*

**1.** The Six-Gun Switch can be installed on the driver's side of the instrument panel (IP) to the left side of the steering column. There are two dash types: Dash 1 (**Figures 10, 11**) and Dash 2 (**Figures 12, 13**).

*NOTE: These are just suggested locations. It is possible to locate the Six-Gun Switch where it is more comfortable. Please confirm space behind dash before drilling.*

**2.** To install on the driver's side IP (Dash 1, **Figure 10**):

Pull the IP trim out by pulling the top edge above the vent as shown in **Figure 14**. Disconnect any switch wires.

**3.** Cut out the supplied template, **Figure 23**, and align the dashed lines to the edge of the IP where you would like to mount the Switch. Tape the template in place. Continue to Step 7.

**4.** To install the Switch to the left side of the steering column (Dash 2 **Figure 13**):

Remove the fuse access panel shown in **Figure 7**. Remove the lower knee

**Figure 10**



**Figure 11**

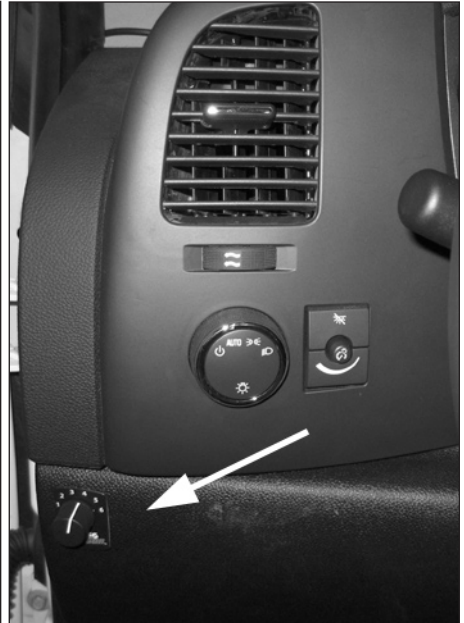

**Figure 12**



**Figure 13**



**Figure 14**



bolster panel by removing the 2 Phillips screws on the lower edge of the panel. Using a 10mm socket and ratchet, unbolt the brake release lever. Pull the panel out by grasping it on either side of the steering column and pull out as shown in **Figure 15**. Disconnect any switch wires.

**5.** Cut out the supplied template, **Figure 23**, and align the template to the right edge of the IP to the left of the steering column. Tape the template in place. A 90° drill will be needed to drill the hole. Continue to Step 7.

**6.** To install Switch as shown in **Figures 11 & 12**:

Follow Step 4 to remove the IP for both Dash styles. Cut out the supplied template, **Figure 24**, and align the template onto the rear of the knee bolster, squarely seating it into the panel corner as shown in **Figure 16**.

**7.** Using a 3/8" Uni-bit step drill bit or a 3/8" drill bit, center the bit onto the 3/8" drill location on the template and slowly drill through the IP. Using a 1/8" drill bit, center and drill through the 1/8" location on the template. Remove and discard the template and any plastic shavings.

**8.** On the front side of where the Switch will be mounted, clean the area with some alcohol and allow it to dry. Remove the backing from the Six-Gun Label and align it over the previously drilled hole.

**9.** Remove the nut and internal tooth washer from the Six-Gun Switch. Rotate the shaft counter clockwise until the shaft stops. Verify the locating washer tab is inserted into the #6 position on the Switch (**Figure 17**).

*NOTE: If the washer is in any position other than the #6, your Six-Gun Diesel Tuner will not select power levels properly.*

**Figure 15**

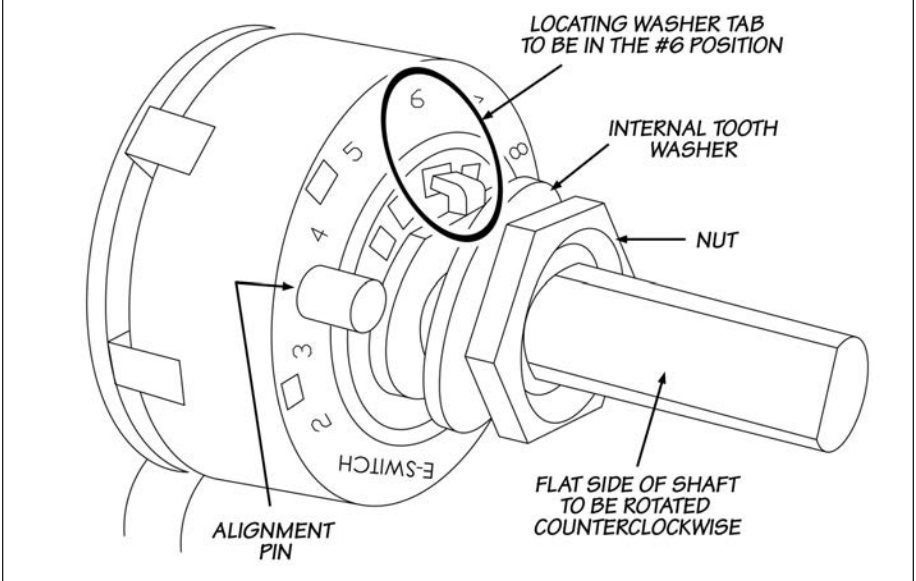



**Figure 16- Rear template used**



**Figure 17**



**10.** After confirming the locating washer is in the #6 location, install the Switch through the  $\frac{3}{8}$ " hole. The alignment pin should rest in the  $\frac{1}{8}$ " hole. With the Switch fully rotated counter clockwise the shaft's flat side should be facing the steering column. Secure the Switch with the internal tooth washer and nut. Snug the washer; be careful not to over torque the nut and damage the plastic threads.

**11.** Install the knob onto the shaft facing the #1 Level on the Six-Gun label. On the knob, snug the two (2) set screws with the supplied 0.050" hex key wrench.

**12.** Route the Six-Gun Switch Cable down to the Six-Gun Diesel Tuner's In-Cab Cable underneath the dashboard, and reinstall any panel(s) that were removed.

*NOTE: Take care to keep any cables away from the pedals or where they could become tangled.*

**13.** Connect the Six-Gun Switch's 2-terminal receptacle to the 2-terminal plug on the Six-Gun Diesel Tuner's In-Cab Cable.

**12.** Re-connect the negative (ground) cable(s).

-END, SECTION 3-

**Figure 18**

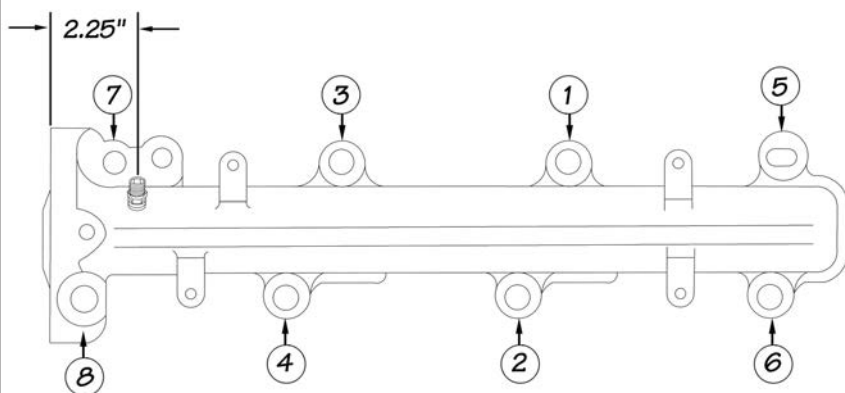

# Section 4

## OPTIONAL THERMOCOUPLE INSTALLATION (REQUIRED FOR OPTIONAL BANKS POWERPDA)

**1.** The thermocouple monitors the temperature of the exhaust gases entering the turbocharger at the turbine housing. Installation requires that the exhaust manifold be drilled near the manifold outlet. It is recommended that the manifold be removed from the engine to thoroughly clean out all metal chips from drilling. If the manifold is not removed from the vehicle, all chips must be removed from the manifold. This may be accomplished by using a magnet to extract the chips after drilling. The tap should be greased before use and the chips again removed with a magnet. All metal shavings must be cleaned from the manifold to avoid turbine damage.

**2.** To access the exhaust manifold, remove front passenger wheel well by removal of plastic retainers.

**3.** On the passenger side, remove the hardware retaining the turbine inlet exhaust pipe to the exhaust manifold. Then, remove the exhaust manifold from vehicle. Pay special attention to the orientation of the manifold outlet gasket. Retain the hardware and gaskets for re-assembly.

**4.** Center punch and drill through the passenger side exhaust manifold into the rear passage at the location shown in **Figure 18**. Use an "R" drill bit, keeping the drill perpendicular to the manifold surface.

**5.** Tap the drilled hole with a 1/8" NPT pipe tap. Check the thread depth as you tap by periodically removing the tap and screwing the thermocouple insert into the tapped hole. The thermocouple insert should be tight and snug when half it's threads are screwed into the manifold.

**6.** Install the thermocouple insert into the manifold using anti-seize compound on the threads. Install the probe in the thermocouple insert.

**7.** Make sure to remove all shavings from inside the exhaust manifold. Reinstall the exhaust manifold. Torque to 28 lb-ft (38 Nm) in the sequence shown in **Figure 18**.

**8.** Route the thermocouple connector along the factory harness to the driver's side and connect it to the Six-Gun's EGT connector. Use the supplied cable ties to secure the harness.

*NOTE: Once the Six-Gun Diesel Tuner is powered up at key-on, it will 'learn' that a thermocouple is installed and automatically enable the EGT limiting function.*

If the thermocouple is removed after being installed and run on the vehicle, the Six-Gun Diesel Tuner will assume that the sensor or connection has gone bad and will cease adding power while triggering the [2,3] diagnostic code (see Troubleshooting Section). To ensure that the Six-Gun Diesel Tuner operates properly after removing a previously installed thermocouple, see the 'Clearing Learned Information' **Section 9**. EGT limiting will not be operational and excessive EGTs may develop at higher power levels.

-END, SECTION 4-

# Section 5

## AUTOMATIC TRANSMISSION LEARNING

*NOTE: Please refer to the Banks PowerPDA Software & Installation Kit Owner's Manual for software installation and operation instruction before beginning **Section 6, Automatic Transmission Learning.***

The 6.6L Chevy Duramax Trucks equipped with the Allison 1000 6-speed automatic overdrive transmission use an adaptive shift control logic. This will require the transmission to adapt to the additional power created by the Banks Power products before it will shift properly. Failure to follow the sequence can result in damage to the transmission.

Perform the following sequence at a location where it is safe to accelerate without exceeding the posted speed limit.

- 1.** Set Six-Gun Tuner to Level 1 power setting, start the truck and allow the engine to reach normal operating temperature.
- 2.** Adjust Six-Gun to Level 2, power setting.
- 3.** Drive vehicle for 5 to 10 miles ensuring a complete shift cycle though each gear. (The transmission shift adaptation learning process requires 15 to 30 complete shift cycles to learn new shift program.)

- 4.** Increase power level by one and repeat Step 3 until the desired power level is achieved.

**WARNING: Take particular care not to do wide open runs in 5th gear when in Automatic transmission Learning Mode.**

The Allison 1000 6-speed automatic transmission will continually adapt to the power output of the engine to optimize shift quality. The transmission will quickly adapt to the power setting if the driving cycle includes regular gear changes at high loads. The transmission learning procedure will need to be repeated when switching back to the higher power settings once the transmission adapts to the lower power settings. It will be apparent when the transmission adapts to the lower settings by monitoring the feel of the gearshift. Gear changes will be noticeably harder when initially switching from a higher to lower power setting. This will soften as the transmission adapts to the new setting.

-END, SECTION 6-

# Section 6

## CHECKING ENGINE PERFORMANCE

The Six-Gun Diesel Tuner requires the engine coolant temperature (ECT) to be above 110° before it will add fuel. If the optional Banks PowerPDA or DynaFact® gauges are installed, observe the operation of the boost and pyrometer (EGT) gauge values while driving under varying conditions. Turbocharger boost pressure will increase as a function of load and engine RPM, thus the engine will produce little boost while cruising at light throttle, with maximum boost while climbing hills, heavily loaded, and/or during acceleration. Note the boost level seen during hard acceleration with a given load. If performance seems to have deteriorated sometime in the future, the maximum boost figures may be compared to see if boost has dropped off. Lower boost may be caused by turbo ducting leaks, a malfunctioning wastegate or fuel injection pump, or dirty air filter. Typical maximum boost pressure settings will vary considerably between automatic transmissions, year model of vehicle, and altitude.

*NOTE: Before key-off, check Tuner for error codes. Use your Banks PowerPDA or EGT gauge to monitor exhaust gas temperature (EGT) in the engine. At idle, exhaust gas temperature will be very low, perhaps only 300°F. As the engine is accelerated for higher speeds with greater loads, the EGT will rise. The highest EGT will be seen under maximum load at full throttle, such as climbing a steep grade with a heavily laden vehicle. To avoid heat damage to various engine components it is recommended that the exhaust gases cool below 400°F before the engine is shut down. Your Six-Gun Diesel Tuner is calibrated to maintain EGTs depending on power level.*

Level	EGT
1-5	1350°F
6	1400°F

*You may experience brief excursions slightly above the temperatures listed under acceleration. This is normal and the EGT should return to or below the proper temperature within a few seconds. If you find that EGT remains high for any length of time, check for boost leaks or a dirty air filter.*

-END, SECTION 7-

# Section 7

## TROUBLESHOOTING

### Six-Gun troubleshooting using the Banks PowerPDA.

Check the Banks PowerPDA's Status Indicator for the "OK" icon. Any Six-Gun Tuner fault will be indicated by the "Banks Engine" icon (see **Figure 19**) and it's cause can be investigated by going to the 'Self Diagnostics' screen and scrolling through the list of logged Tuner events.

**Figure 19**



SIX-GUN TUNER ICON

1. Press the center button on the 5-way navigator (**Figure 20**) to take you to the System Menu screen.

2. Touch the button labeled 'More>' to move to the second screen of the System Menu

3. Next, touch the 'Self Diagnostics' button. (See **Figure 21**)

4. The 'Self Diagnostics' screen displays a log of diagnostic events related to the Six-Gun Tuner (See **Figure 22**). The 'Logged Events' list takes a moment to update each time this screen is opened (as indicated by a slight flickering of the list). Once the list is updated, the most current event will appear at the top of the list. Each event has an associated time stamp and description, which will be

**Figure 20**

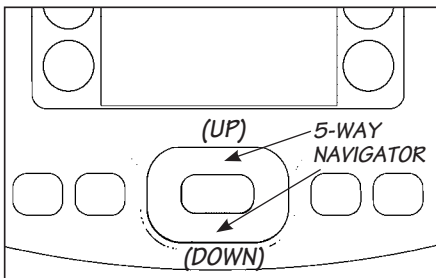

displayed below the list when that event is highlighted. Each key cycle of the vehicle produces a minimum of two logged events.

5. Touch the 'Down' or 'Up' buttons to scroll through the list of recorded events. **Table 1** lists the available diagnostic codes and the recommended course of action for each.

6. Touch the center button on the 5-way navigator (or the 'Back' button) to return to the System-Monitor screen.

**Figure 21**



**Figure 22**

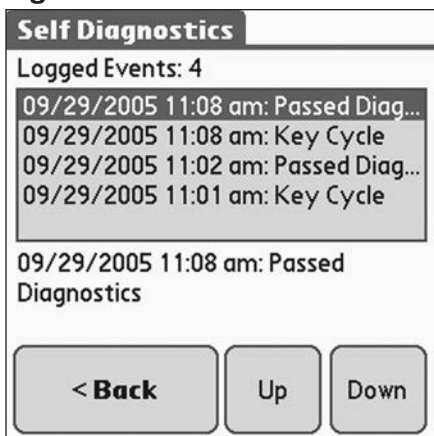

## Six-Gun Troubleshooting using the Tuner's LEDs.

*(With or without a Banks PowerPDA Installed)*

If you feel that your Six-Gun Diesel Tuner is not functioning properly, some diagnostics can be performed. Your Six-Gun Diesel Tuner is equipped with diagnostic features that will detect and display certain errors.

Remove the Six-Gun Diesel Tuner from its mounting location while keeping all connectors plugged in, and position it in such a way that you can view the end of the Six-Gun housing that contains the LEDs from the driver's seat. Turn the vehicle key to the ON position. Observe the two LEDs mounted on the end of the Six-Gun Diesel Tuner:

- A steady GREEN LED will illuminate if all wire connections are correct, the engine is running, and the engine coolant temperature is within its normal operating range.
- The GREEN LED will flash if all wire connections are correct, the engine is running, but the engine coolant temperature is not within its normal operating range. The GREEN LED will stop flashing once the engine coolant temperature is within its normal operating range (not to be confused with Speed-Loader flash on power-up).
- No LEDs will illuminate if the fuse on the Six-Gun wiring harness is blown or the wiring harness is not properly connected. If the fuse and all connections are okay, contact Banks Technical Service.

- The RED LED will flash in a certain sequence if a connection is incorrect or if there is a problem with the system – this sequence will identify one or more diagnostic codes. A Six-Gun Diesel Tuner's diagnostic code is comprised of 2 digits. Each code is expressed in a sequence of 2 sets of the flashing red LED separated by a brief flashing of the green LED in between. Each set of a number of red LED flashes represents a digit. A longer flashing of the green LED separates the sequences. The LEDs will continue to flash to display all the errors, and then repeat. **Table 1** lists common diagnostic codes. For example, if a faulty thermocouple is detected (code "2,3") by the Six-Gun Diesel Tuner, the following red and green LED flashing sequence is observed when the key is on:

- (1) Two times flashing RED LED
- (2) One time quick flashing GREEN LED
- (3) Three times flashing RED LED
- (4) One time longer flashing GREEN LED

The above flashing sequence will repeat continuously. When the problem is corrected, the diagnostic code will be eliminated and replaced by a steady green light. If the problem persists, contact Banks Technical Service.

*NOTE: If multiple codes are set, they will be displayed in a series separated by the longer flashing green LED. When reading codes, make sure to watch the entire series until you see the first code repeat.*

-END, SECTION 8-

**Table 1:** Six-Gun Troubleshooting

<b>Code</b>	<b>PDA Error Message</b>	<b>Corrective Action</b>
<b>1,1</b>	Fuel Rail Pressure (FRP) Input Voltage Out of Range.	Turn ignition OFF for 60 seconds and check the black and gray connectors. Turn ignition back ON and re-check for presence of code.
<b>1,2</b>	Manifold Absolute Pressure (MAP) Input Voltage Out of Range.	Turn ignition OFF for 60 seconds and check the gray and black connectors. Turn ignition back ON and re-check for presence of code.
<b>1,3</b>	Six-Gun Switch Input Value Out of Range.	Turn ignition OFF for 60 seconds and make sure either Banks PowerPDA or Six-Gun switch is connected to the Six-Gun tuner. If the Six-Gun switch is connected (no Banks PowerPDA), check the 2-terminal connection on Tuner's In-Cab cable. If the PowerPDA is connected (no Banks Six-Gun switch), check the 4-terminal connection on the Tuner's In-Cab cable. Turn ignition back ON and re-check for presence of code.
<b>1,4</b>	Mass Air Flow (MAF) Input Voltage Out of Range.	Turn ignition OFF for 60 seconds and check the 5-Terminal MAF connector. Turn ignition back ON and re-check for presence of code.
<b>2,1</b>	Fuel Rail Pressure (FRP) Output Voltage Out of Range.	The FRP sensor may be bad. Turn ignition OFF for 60 seconds and check the gray and black connectors. Turn ignition back ON and re-check for presence of code.
<b>2,2</b>	Manifold Absolute Pressure (MAP) Output Voltage Out of Range.	The MAP sensor may be bad. Turn ignition OFF for 60 seconds and check the black and gray connectors. Turn ignition back ON and re-check for presence of code.
<b>2,3</b>	Exhaust Gas Temperature (EGT) Sensor Circuit Fault.	Turn ignition OFF for 60 seconds and check the thermocouple connectors. Turn ignition back ON and re-check for presence of code.
<b>2,4</b>	Mass Air Flow (MAF) Output Voltage Out of Range.	The MAF sensor may be bad. Turn ignition OFF and check the 5-Terminal MAF connector. Turn ignition back ON and re-check for presence of code.
<b>3,1</b>	Engine Position Sensor Fault.	Turn ignition OFF for 60 seconds and check the gray and black connectors. Turn ignition back ON and re-check for presence of code.
<b>3,2</b>	Internal Module Malfunction or Intermittent Power.	Turn ignition OFF for 60 seconds and check the black and gray connectors. Check the Tuner's fuse. Turn ignition back ON and re-check for presence of code.
<b>3,3</b>	EGR Valve Position Input Voltage Out of Range.	Turn ignition OFF and check the black and gray connectors. Turn ignition back ON and re-check for presence of code.
<b>3,4</b>	OBDII CAN communication error	Turn ignition OFF for 60 seconds and check the gray and black connectors. Turn ignition back ON and re-check for presence of code.
<b>4,1</b>	Injection Control Signal Fault.	Turn ignition OFF for 60 seconds and check the gray and black connectors. Turn ignition back ON and re-check for presence of code.
<b>4,2</b>	Transmission Slippage Detected.	Transmission is slipping excessively. Code will automatically clear once transmission stops slipping (repaired). If code is thrown, torque convertor needs to lock and unlock 5x before code is cleared from transmission.
<b>4,3 or 4,4</b>	Internal Module Malfunction.	Turn ignition OFF. Turn ignition back ON after 60 seconds and re-check for presence of code. If error is still present, turn ignition OFF and check all connectors. Check the Tuner's fuse. Turn ignition back ON and re-check for presence of code.

If any code is displayed or is persistent, pull the connectors apart and check the terminals. A terminal may not have been seated correctly during manufacturing and it may have moved when connected. If it appears that a terminal has moved, gently pull on it with small needle nose pliers to lock it in place.



# Section 8

## CLEARING LEARNED INFORMATION

If the Six-Gun Diesel Tuner has been moved to a different vehicle, or you are instructed to do so by Banks Technical Staff, it is possible to reset all of the parameters that the Six-Gun has 'learned' - presence of an EGT thermocouple or Speed-Loader, etc.

**CAUTION: The following procedures can only be carried out with the engine OFF!**

**1.** Turn the vehicle key to ON but DO NOT start the engine.

**2.** Fully depress the throttle pedal and then release it completely. Repeat 5 times. The Tuner's GREEN LED will flash when this is completed successfully.

**3.** Turn the key OFF. Wait 60 seconds and make sure the GREEN LED goes off and stays off. Turn the key back to the ON position but DO NOT start the engine.

**4.** Fully depress the throttle pedal and then release it completely. Repeat 5 times.

-END, SECTION 9-

# Section 9

## REMOVAL OF THE SIX-GUN DIESEL TUNER

If the Six-Gun Diesel Tuner should ever need to be removed from the vehicle, perform the following:

**1.** Disconnect the negative (ground) cable from the battery (or batteries, if there are two) before beginning work.

**2.** Disconnect the Six-Gun's gray connector from the factory harness.

**3.** Re-connect the vehicle's gray connector back into the factory harness.

**4.** Disconnect the Six-Gun's black connector from the factory harness.

**5.** Re-connect the vehicle's black connector back into the factory harness.

**6.** Disconnect the EGT thermocouple connector. The thermocouple may be left in place or removed if a suitable plug is used.

**7.** Disconnect the 'In-Cab Cable' and gently pull the cable back through the firewall.

**8.** Remove the Six-Gun Diesel Tuner. Failure to follow the above instructions when removing the Tuner will result in a "Check Engine" light on the dash and a Diagnostic Trouble Code being stored in the factory computer, in addition to the engine not running.

**4.** Re-connect the negative (ground) cable(s).

-END, SECTION 10-

# Section 10

## PLACEMENT OF THE BANKS POWER DECALS

Figure 25

TYPICAL LEFT FENDER PLACEMENT

**BANKS  
POWER**

**DURAMAX DIESEL**



TYPICAL RIGHT FENDER PLACEMENT

**BANKS  
POWER**

**DURAMAX DIESEL**

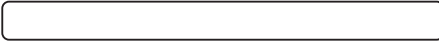

**Figure 23- Use only when drilling from the front**

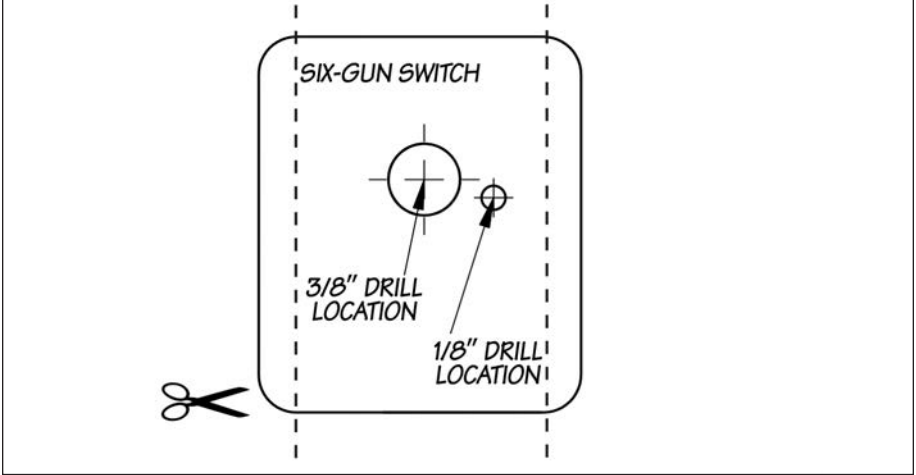

**Figure 24- Use only when drilling from the rear**

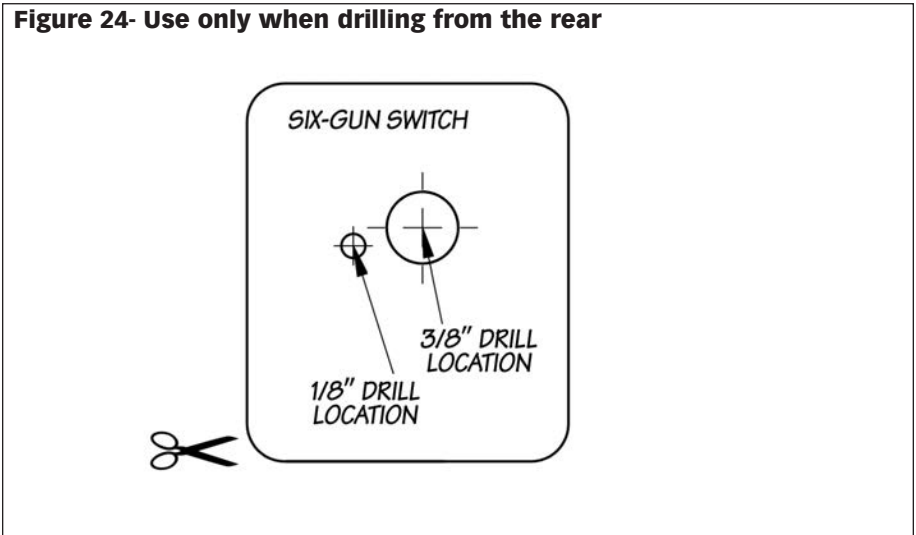

Gale Banks Engineering  
546 Duggan Avenue • Azusa, CA 91702  
(626) 969-9600 • Fax (626) 334-1743

Product Information & Sales: (888) 635-4565  
Customer Support: (888) 839-5600  
Installation Support: (888) 839-2700

**bankspower.com**

Palm® is a registered trademark, and Tungsten™ is a trademark of Palm Inc.