

Owner's Manual with Installation Instructions

Banks Monster[®] Exhaust System

**2001-2007 (LB7, LLY & LBZ) Chevy/GMC 6.6L
Duramax Turbo-Diesel Pickups**

THIS MANUAL IS FOR USE WITH SYSTEM
48628-48634, 48937-48941

Gale Banks Engineering
546 Duggan Avenue • Azusa, CA 91702
(626) 969-9600 • Fax (626) 334-1743

Product Information & Sales: (800) 438-7693
Customer Support: (888) 839-5600
Installation Support: (888) 839-2700

bankspower.com

General Installation Practices

Dear Customer,

If you have any questions concerning the installation of your Banks Monster Exhaust System, please call our Technical Service Hotline at (888) 839-2700 between 7:00 am and 4:00 pm (PT). If you have any questions relating to shipping or billing, please contact our Customer Service Department at (888) 839-5600.

Thank you.

1. Before starting work, familiarize yourself with the installation procedure by reading all of the instructions.
2. The exploded view (**Figure 1**) provides only general guidance. Refer to each step and section diagram in this manual for proper instruction.
3. Throughout this manual, the left side of the vehicle refers to the driver's side, and the right side to the passenger's side.
4. Disconnect the negative (ground) cable from the battery (or batteries, if there are two) before beginning work.
5. Route and tie wires and hoses a minimum of 6" away from exhaust heat, moving parts and sharp edges. Clearance of 8" or more is recommended where possible.
6. When raising the vehicle, support it on properly weight-rated safety stands, ramps or a commercial hoist.

Follow the manufacturer's safety precautions. Take care to balance the vehicle to prevent it from slipping or falling. When using ramps, be sure the front wheels are centered squarely on the topsides; put the transmission in park; set the hand brake; and place blocks behind the rear wheels.

Caution! Do not use floor jacks to support the vehicle while working under it. Do not raise the vehicle onto concrete blocks, masonry or any other item not intended specifically for this use.

7. During installation, keep the work area clean. Do not allow anything to be dropped into intake, exhaust, or lubrication system components while performing the installation, as foreign objects will cause immediate engine damage upon start-up.

Tools Required:

- 1/2" and 3/8" drive ratchets with standard and metric sockets and 1/2" and 3/8" drive extension
- Standard and metric combination or open-end wrenches
- Standard screwdriver
- Clean shop towels or rags
- Pry-bar

Highly recommended tools and supplies:

- Foot-pound torque wrench
- Penetrating oil or light lubricant spray

Figure 1 Banks Monster Exhaust, General Assembly

Item #	Description	Part #	QTY
1	2001-05 Intermediate pipe*	53713	1
1a	2001-07 Front, Intermediate pipe	53745 / 53729	1
1b	2001-07 Rear, intermediate pipe	53730	1
2	Flange pipe	53713 / 53717	1
3	Front, Tailpipe	53710 / 53728	1
3b	Rear, Tailpipe	53711	1
4	Monster muffler	53800 / 53801	1
5	4" Exhaust clamps	52471	3
6	4" Exhaust hanger/clamp	53707	1
7	4" Band clamp**	52471	1
8	Exhaust gasket**	93210	1
9	Chrome exhaust tip	52730	1
10	Head pipe assembly** <i>Systems 48628, 48629 and 48630 only (non-cat models)</i>	48631	1
11	7/16-20 x 1.5" Bolts** <i>Systems 48628, 48629 and 48630 only (non-cat models)</i>	91629	4
12	7/16-20 Crimplock nuts** <i>Systems 48628, 48629 and 48630 only (non-cat models)</i>	91619	4
13	7/16 AN washers** <i>Systems 48628, 48629 and 48630 only (non-cat models)</i>	91601	4
14	3.5" exhaust clamp (saddle type)	52467	1
15	Banks Decals	96009	2

*Substitute 1 with 1a & 1b depending on cab configuration and year range

**Excludes 2006-2007 models

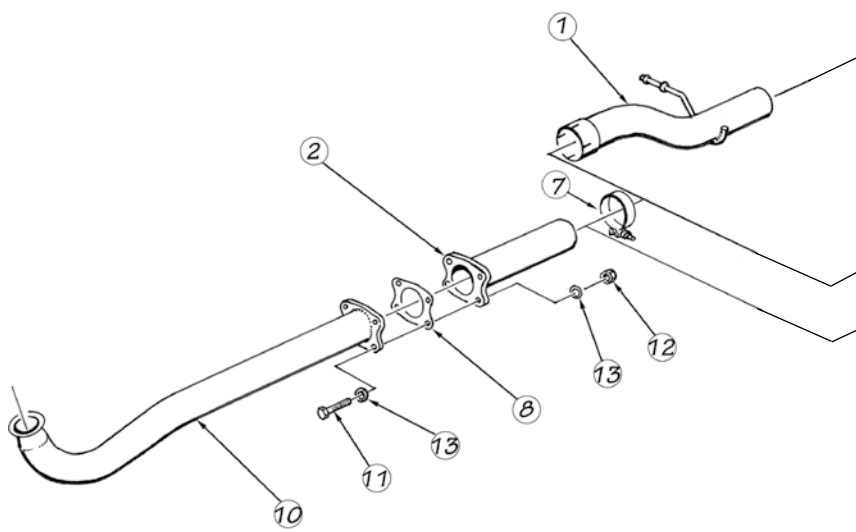

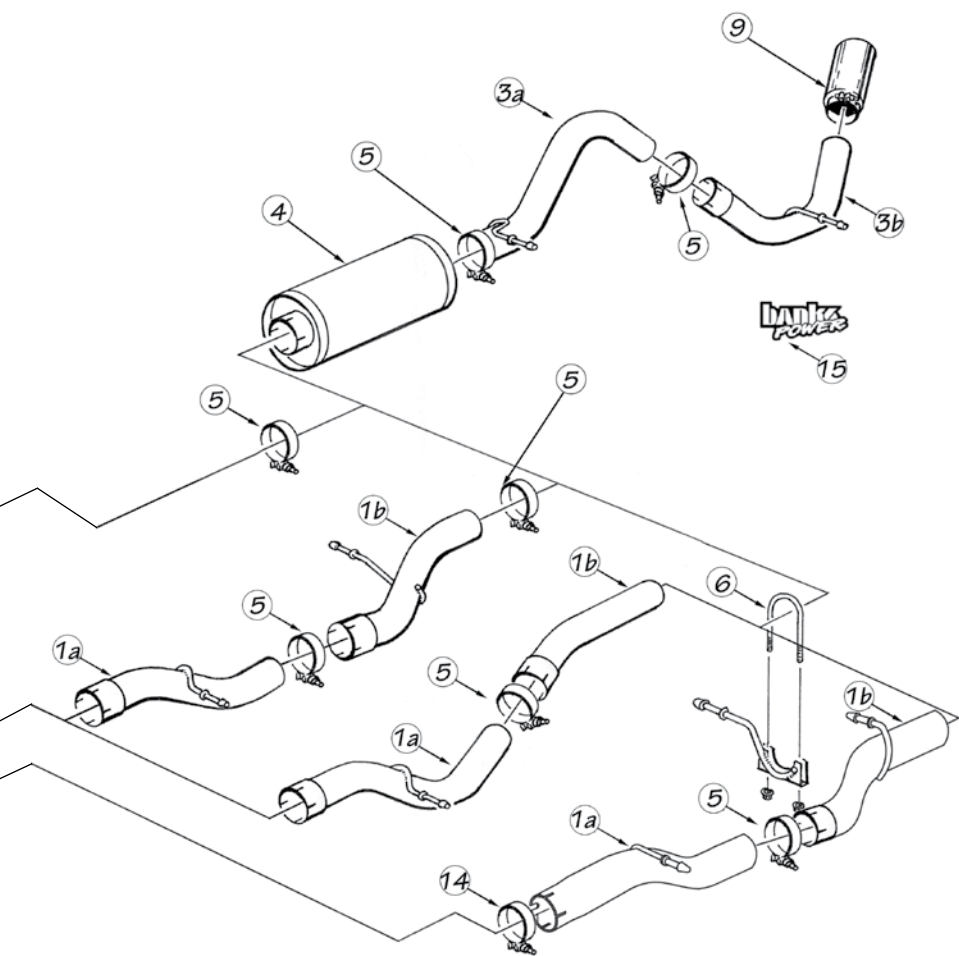

Exhaust System Installation

1. As a precaution, disconnect the ground of the battery (if there is more than one battery, disconnect both).

2. Raise the vehicle and support it with properly weight rated safety stands, ramps or a commercial hoist. Follow the manufacturer's safety precautions. Take care to balance the vehicle to prevent it from slipping or falling. When using ramps, be sure the front wheels are centered squarely on the topsides; place the transmission in park; set the parking brake and place blocks behind the rear wheels.

CAUTION: DO NOT WORK UNDER ANY VEHICLE SUPPORTED ONLY BY A JACK. SEVERE INJURY MAY RESULT.

3. Removal of the factory exhaust can be simplified by cutting the factory exhaust pipe behind the muffler. This will allow the tailpipe to be removed as a separate piece.

4. For 2006-07 models, remove the clamp located on the catalytic converter outlet.

5. For 2001-05 models, remove the four (4) nuts from the factory exhaust flange located at the back side of the factory head pipe (retain for re-use).

6. Remove the factory tailpipe from the vehicle by disengaging the exhaust system hanger pins from the rubber hangers using a large screw-driver or pry bar.

Note: Lubricating the rubber hangers with WD-40 or similar lubricant will ease removal of the hanger pins.

7. Remove the factory muffler from the vehicle by disengaging the hanger pins from the rubber hangers using a large screwdriver or pry bar.

NOTE: If Banks Headpipe (system 48670, 48671 or 48672) is being installed, perform steps 8 thru 11 below. Otherwise

continue installation with step 12.

8. On the front of the exhaust, spray penetrating oil such as WD-40 on the T-bolt of the factory V-band clamp to prevent galling. Remove factory V-band clamp and save for re-use.

9. Remove factory head pipe from the vehicle by disengaging the exhaust system hanger pins from the rubber grommets using a large screwdriver or pry bar.

10. Install Banks head pipe in vehicle and insert the hanger pin in the rubber exhaust grommet.

NOTE: Be sure to install the hanger pin in the same location as the previously removed factory head pipe.

11. Loosely install the V-band clamp on head pipe flange and only tighten the T-bolt on the clamp to the point that the pipe is snug but can still be rotated in the clamp for adjustment/alignment.

NOTE: Do not completely tighten the V-band clamp at this point.

NOTE: proceed to step 14 for 2006-07 models installation instructions

CAUTION: The following step involves cutting a stainless steel tube. Safety glasses should be worn during any cutting operation and care should be taken to avoid injury due to sharp edges and burrs.

12. For ECLB and ECSB models only: Cut the Banks Flanged intermediate pipe (53717) based on the following configurations. See **Table 1**. Cut the Non-flanged end of the intermediate pipe. See **Figure 2**.

13. Install the Banks flanged intermediate pipe and 4-bolt gasket onto the headpipe. Loosely assemble with the four (4) factory nuts or if

Figure 2

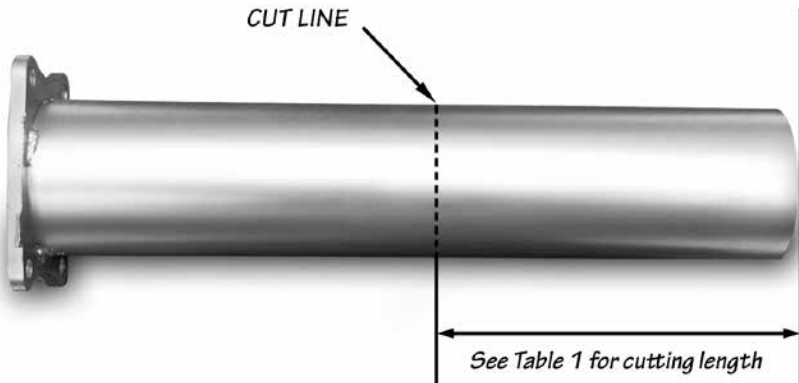

Table 1

2001-2007 Chevy/GMC 6.6L Duramax	
	Cut Flanged Intermediate pipe to Length
Standard Cab/ Long Bed (SCLB)	No Cut
Extended Cab/ Short Bed (ECSB)	9 1/2"
Extended Cab/ Long Bed (ECLB)	9 1/2"
Crew Cab/ Short Bed (CCSB)	No Cut
Crew Cab/ Long Bed (CCLB)	No Cut

optional headpipe was installed use the supplied 7/16" bolts, washers and nuts. Slide the Banks 4-inch band clamp on the outlet of the Banks 4-bolt flange pipe.

14. For 2006-07 models, install a 3.5" clamp onto the catalytic converter outlet.

15. One-piece Intermediate pipe ONLY Insert the intermediate pipe inlet onto the flanged intermediate pipe or catalytic converter outlet. Install the intermediate pipe hanger pin(s) into the vehicle rubber hangers.

Two-piece Intermediate pipe ONLY Insert the Front intermediate pipe inlet onto the flanged intermediate pipe or catalytic converter outlet. Install the Front intermediate pipe hanger pin into the vehicle rubber hangers. Loosely tighten the clamp on the Front intermediate pipe inlet to secure it. Install a 4" clamp onto the Front Intermediate pipe outlet. Insert the Rear intermediate pipe inlet into the Front intermediate pipe outlet. Install the Rear intermediate pipe hanger pin into the vehicle rubber hangers (if applicable). Loosely tighten the clamp on the Front intermediate pipe outlet to secure it.

NOTE: Once the pipe has been completely engaged in the slip joint, it should be marked with a marker, scribe or tape for reference when tightening

clamps later in the installation. Each slip joint in the system should be marked in this fashion. When the exhaust system is being adjusted to align the hangers, the slip joints can be adjusted so that the reference mark is no more than 1/4" away from its original position.

16. Slide one (1) of the supplied 4-inch exhaust clamps over the Banks Rear intermediate pipe outlet.

Note: On extended-cab long-bed and crew-cab long-bed vehicles, the clamp that is used between the intermediate pipe and muffler is a combination hanger/clamp. When this hanger clamp is installed the hanger pin should be inserted into the factory rubber hanger and the clamp should be rotated until the hanger pin is parallel with the frame mounted pin before being torqued.

17. Install the muffler onto the end of the intermediate pipe outlet. Be sure that the inlet side of the muffler (see markings on muffler body) is facing toward the front of the vehicle. Orient the muffler such that the "Banks Monster" logo is facing towards the frame and is level with the ground. Verify that the muffler

and intermediate pipe are completely engaged.

18. Slide one (1) of the supplied 4" exhaust clamps onto the Banks Monster muffler outlet.

19. Install the Front tailpipe inlet into the muffler outlet. Be sure that the two pipes are completely engaged. Insert the Front tailpipe hanger pin into the factory rubber hanger. Loosely tighten the clamp on the Muffler outlet to secure the Front tailpipe. Install a 4" clamp onto the Front tailpipe outlet. Install the Rear tailpipe inlet into the Front tailpipe outlet. Insert the Rear tailpipe hanger pin into the factory rubber hanger. Loosely tighten the clamp on the Front tailpipe outlet to secure the Rear tailpipe.

Rotate the tailpipe until the hanger pins are parallel with the frame mounted pin.

NOTE: Minimum distance between exhaust tip and body is one (1) inch.

20. Tighten the head pipe V-band clamp to 12 ft-lbs (if previously loosened).

Figure 3

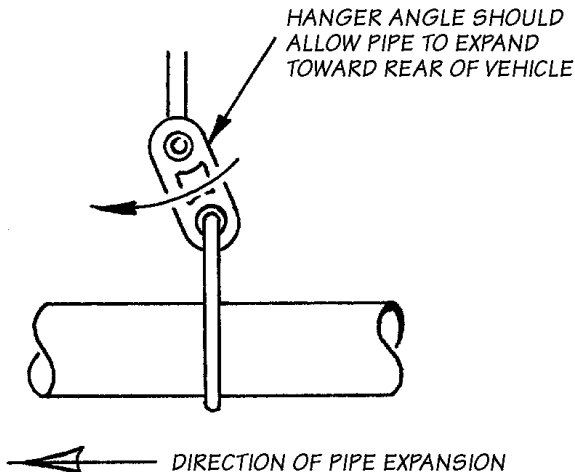
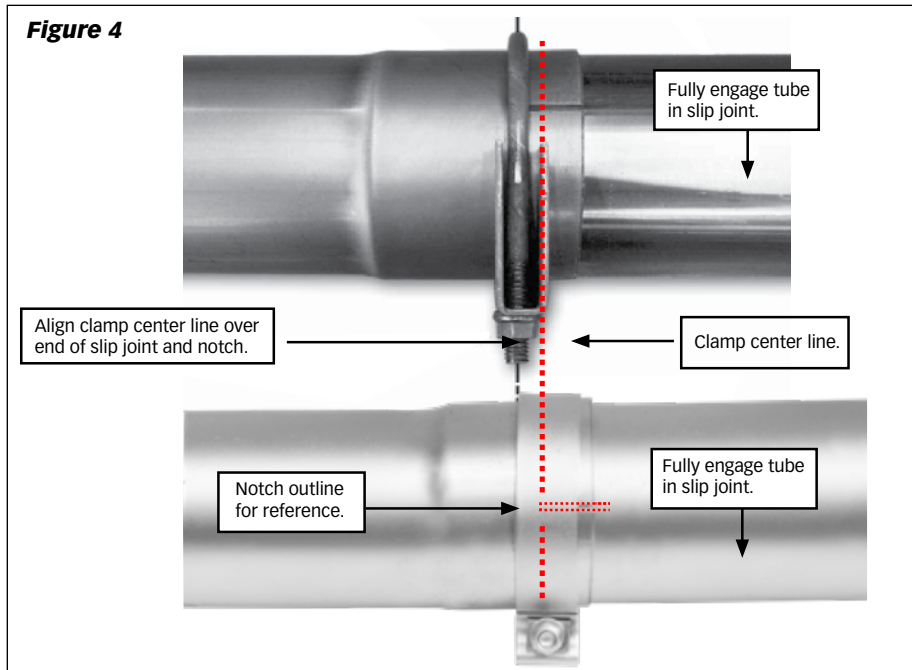

Figure 4



21. Adjust each of the pipes to ensure that all of the hanger pins are parallel with the frame mounted pins and that the rubber hangers are all positioned slightly forward (See **Figure 3**). The amount of forward angle on the rubber hangers should increase the farther downstream the hanger is positioned. This allows the hangers to be properly positioned once the exhaust system reaches operating temperature.

22. Install the exhaust clamp at each of the three (3) joints. **Figure 4** illustrates the proper location of an exhaust clamp on a tubing joint. Torque the nuts on each of the exhaust and saddle clamps to 35 ft-lb, or until saddle clamp begins to deform.

Note: If a combination hanger/clamp is utilized. The clamps only need to be tight enough to form a seal and hold the pipes together. Over tightening the clamps may cause the system to leak due to the pipe being crimped.

23. Install exhaust tip by sliding it over the outlet of the tailpipe. The tip should

be positioned so that the outlet of the exhaust tip is approximately one (1) inch past the outlet of the tailpipe.

NOTE: On vehicles with dual rear wheels, the outlet of the tip should be placed approximately 3.5 inches past the outlet of the tailpipe. Torque the band clamp to 50 ft-lb.

24. Remove the protective covering from the tailpipe tip.

Caution: the protective covering may ignite and burn if not removed prior to running the engine.

25. Your system includes two (2) Banks Power decals designed to complement the Duramax emblems on the vehicles front doors.

26. Re-connect the negative battery cable. Start the engine and listen for exhaust leaks. Tighten the exhaust clamps as necessary. Whenever possible, tack weld slip connections to prevent disengagement is recommended. The Banks Monster Exhaust installation is now complete.

Gale Banks Engineering
546 Duggan Avenue • Azusa, CA 91702
(626) 969-9600 • Fax (626) 334-1743

Product Information & Sales: (800) 438-7693
Customer Support: (888) 839-5600
Installation Support: (888) 839-2700

bankspower.com