

**banks**

with Installation Instructions

# Owner's Manual

## **Banks Monster<sup>®</sup> Exhaust System**

### **2014-2019 Ram 1500, 3.0L EcoDiesel Factory Single/Side Exit Exhaust**

THIS MANUAL IS FOR USE WITH MONSTER EXHAUST SYSTEMS  
48601 & 48601-B

Gale Banks Engineering  
546 Duggan Avenue • Azusa, CA 91702  
(626) 969-9600 • Fax (626) 334-1743

Product Information & Sales: (888) 635-4565  
Customer Support: (888) 839-5600  
Installation Support: (888) 839-2700

**bankspower.com**

**banks**

# Products available from Banks Power for the 2015 Ram 1500 3.0L EcoDiesel

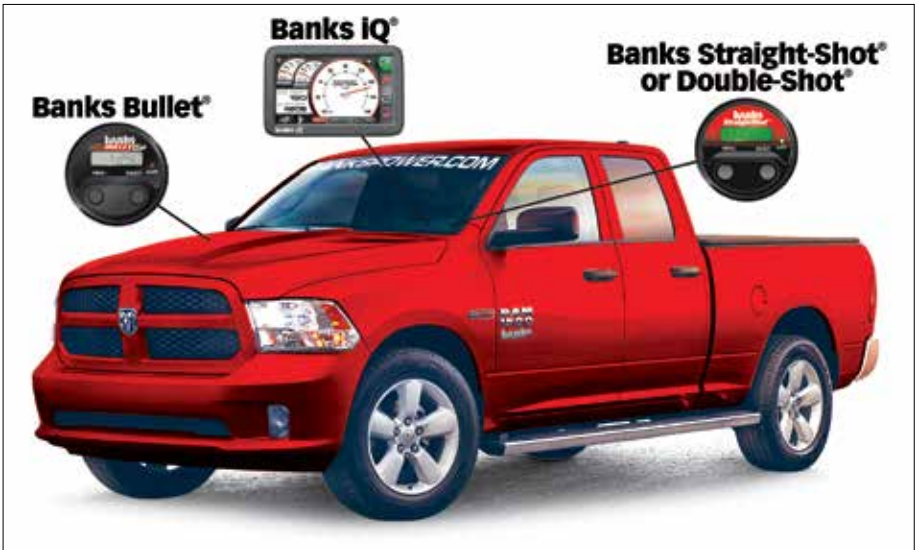

## **Banks Straight-Shot® Water-Methanol Injection (P/N 45000)**

- Maximizes Engine Performance
- Cools Intake Temperatures
- Digital Controller (included)
- Plug-and-Play wiring
- Greater flow than the competition
- Higher Pump Volume than the competition
- Multiple configurations available

## **Banks Double-Shot® Water-Methanol Injection (P/N 45002)**

- The Double-Shot system offers the same benefits of the Straight-Shot and adds a second stage for increased output and control.
- EGT sensor is included to serve as a trigger or auxiliary sensor.
- Multiple Tanks Sizes Available.

## **Banks Bullet® Tuner (P/N 66526, P/N 66527)**

- Tunable (stock/tow/sport levels), plug-and-play power adder
- Displays boost and EGT with optional thermocouple as a trigger or auxiliary sensor.
- Adds up to **33HP/57 lb-ft** tuner only, and up to **42HP/75 lb-ft** with airflow improvements

## **Banks iQ® System (P/N 61201)**

- 5" touchscreen interface
- Interchangeable gauge display, read and clear codes, monitor engine diagnostics, log data, time your vehicles runs and much more.
- Built-in rechargeable lithium-ion battery automatically charges while connected to the vehicle
- Built-in GPS antenna
- Hands-free calling
- Backup camera ready
- Navigation ready

## **COMING SOON:**

### **Banks Ram-Air® Intake System**

- Extensively tested & validated
- Increases air density, power & fuel economy
- Reduces exhaust gas temps (EGTs)
- Outflows stock up to 50%

### **Banks Techni-Cooler® Intercooler System**

- It's all bigger: boost tubes, aluminum end tanks, inlet/outlet and core area. Much greater flow volume. Increases air density for higher continuous power.

**For More Information please call (888) 635-4565  
or Visit us online @ [www.bankspower.com](http://www.bankspower.com)**

# General Installation Practices

If you have any questions concerning the installation of your Banks Monster Exhaust System, please call our Technical Service Hotline at (888) 839-2700 between 7:00 am and 4:00 pm (PT). If you have any questions relating to shipping or billing, please contact our Customer Service Department at (888) 839-5600.

Thank you.

1. Before starting work, familiarize yourself with the installation procedure by reading all of the instructions.
2. The exploded view (**Figure 1**) provides only general guidance. Refer to each step and section diagram in this manual for proper instruction.
3. Throughout this manual, the left side of the vehicle refers to the driver's side, and the right side to the passenger's side.
4. Disconnect the negative (ground) cable from the battery (or batteries, if there are two) before beginning work.
5. Route and tie wires and hoses a minimum of 6" away from exhaust heat, moving parts and sharp edges. Clearance of 8" or more is recommended where possible.
6. When raising the vehicle, support it on properly weight-rated safety stands, ramps or a commercial hoist. Follow the manufacturer's safety precautions. Take care to balance the vehicle to prevent it from slipping or falling.

When using ramps, be sure the front wheels are centered squarely on the topsides. When raising the front of the vehicle, put the transmission in park,

set the parking brake, and block the rear wheels. When raising the back of the vehicle, be sure the vehicle is on level ground and the front wheels are blocked securely.

**⚠ CAUTION:** Do not use floor jacks to support the vehicle while working under it. Do not raise the vehicle onto concrete blocks, masonry or any other item not intended specifically for this use.

**7.** During installation, keep the work area clean. Do not allow anything to be dropped into intake, exhaust, or lubrication system components while performing the installation, as foreign objects will cause immediate engine damage upon start-up.

## Tools Required:

- 1/2" and 3/8" drive ratchets with standard and metric sockets and 1/2" and 3/8" drive extension
- Standard and metric combination or open-end wrenches
- Standard screwdriver
- Clean shop towels or rags
- Pry-bar

## Highly recommended tools and supplies:

- Pound-feet torque wrench
- Penetrating oil or light lubricant spray

## Table of Contents

<b>Section 1</b> .....	<b>4</b>
General Assembly	
<b>Section 2</b>	
Monster Exhaust Installation .....	<b>6</b>

# General Assembly

Figure 1

Item #	Description	P/N	QTY
1	Intermediate Pipe	52752	1
2	Tailpipe, Front	52753	1
3	Tailpipe, Rear	52754	1
4	Band Clamp, 3"	52466	1
5	Exhaust Clamp, 3.5"	52468	2
6	Band Clamp, 3.5"	52467	1
7	Tailpipe Tip, Chrome/Black	52722/52723	1
8	Banks Decal	96009	2

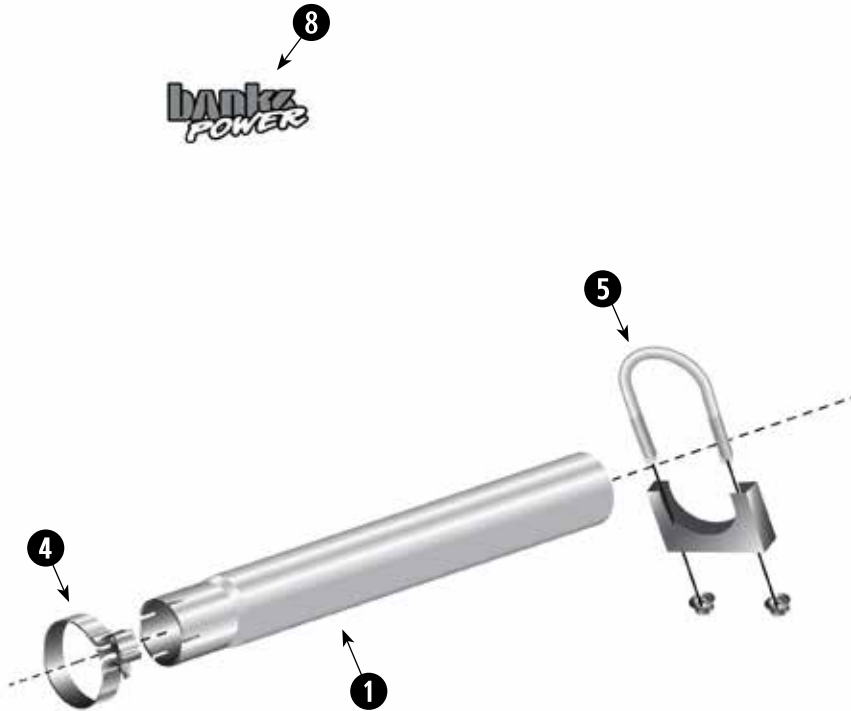

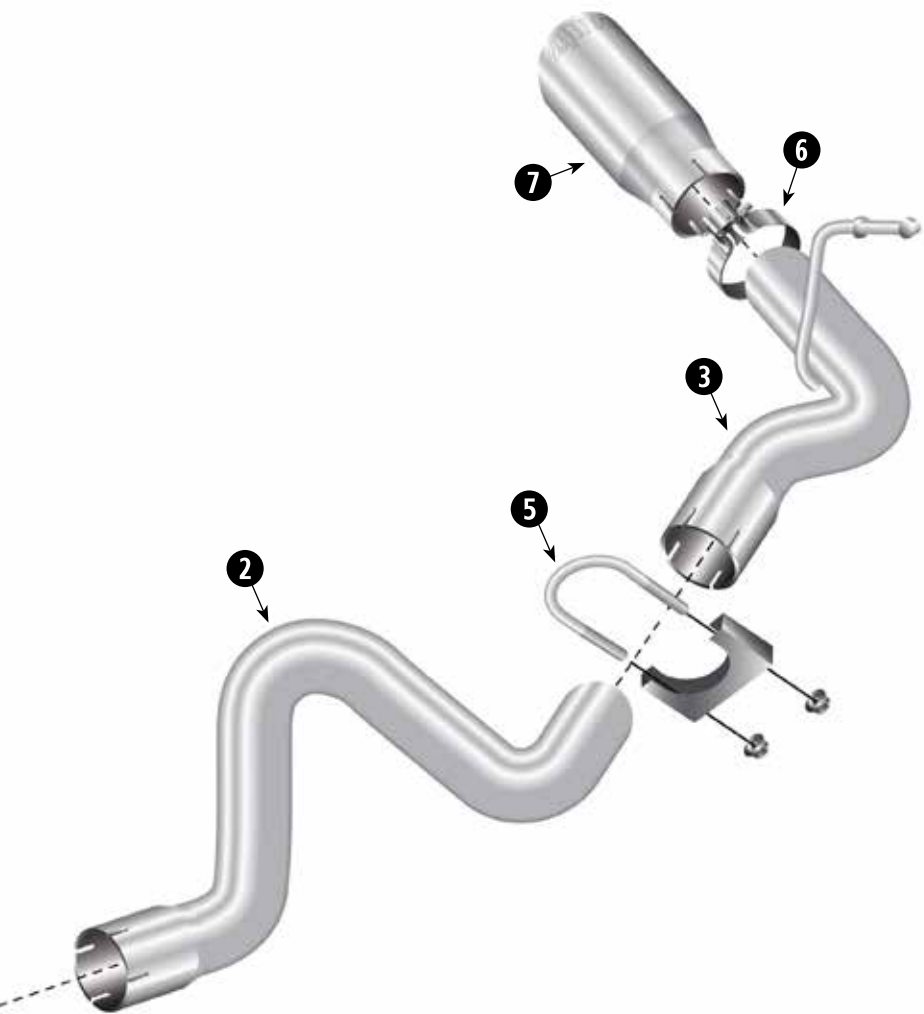

# Monster Exhaust System Installation

**1.** Disconnect the negative (ground) cable from the battery (if there is more than one battery, disconnect both negative cables). Secure the cable so it cannot accidentally come in contact with the post.

**2.** Raise the vehicle and support it securely with properly weight-rated safety stands, ramps or a commercial hoist. Take care to balance the vehicle to prevent it from slipping or falling. When using ramps, be sure the wheels are centered squarely on the topsides. Place the transmission in park (automatic), set the parking brake and securely block the wheels that are on the ground.

**⚠ CAUTION:** Do not work under any vehicle supported only by a jack. Severe injury may result.

**NOTICE:** Spray lubricant may assist

*in hanger pin removal. Rubber hangers can also be removed from the vehicle to assist in muffler removal.*

**3.** Disengage factory rear tailpipe hanger by prying/pressing tailpipe hanger pin out of rubber isolator, then loosen factory band clamp at rear of main (larger) muffler. *Tools used: 15 mm socket/wrench, prybar.*

**4.** Remove factory tailpipe/resonator assembly by sliding out over axle, towards rear of truck.

**5.** Disengage the remaining hanger pin Disengage both factory muffler hangers, then loosen factory band clamp at front of muffler. *Tools used: 15 mm socket/wrench, prybar.*

**6.** Remove factory muffler assembly by sliding towards rear of truck. Factory rubber muffler hanger isolators can be removed from truck, they will not be re-used.

**Figure 2**

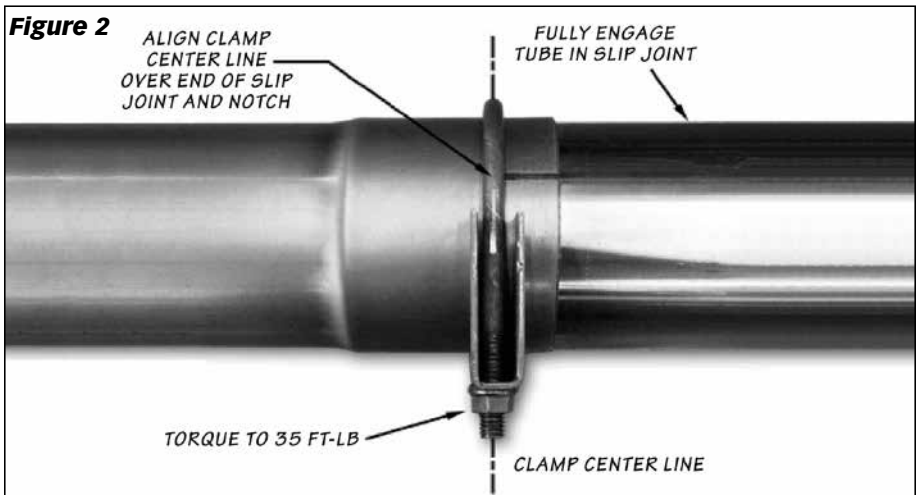

**NOTICE:** All clamps should be positioned at the beginning of the slots (on the 1/2 circle punch). See **Figure 2**.

2. Once the pipe/ muffler has been completely engaged in the slip joint, mark the pipe with a scribe or tape for reference when tightening the clamps later in the installation. Mark each slip joint in this fashion.

7. Loosely install the 3" band clamp onto the inlet of the Monster Exhaust intermediate pipe, then install the intermediate pipe onto the vehicle. The OE alignment tab on the DPF-outlet pipe should fully engage the corresponding notch on the Monster Exhaust intermediate pipe. See **Figure 3**.

3. Tools used: 15mm socket

8. Loosely install a 3.5" exhaust clamp onto the inlet of each Monster Exhaust Tailpipe, then install the tailpipes onto the vehicle. Engage the rear Monster Exhaust tailpipe hanger into the factory rubber isolator. Tools used: 15 mm socket/wrench, prybar.

9. Loosely install a 3.5" band clamp onto the inlet of the tailpipe tip, then install the tip onto the tailpipe. Adjust

the tailpipe joint rotation to align. Slide the tip in or out to adjust tip extension past body to preference, and orient the logos facing upwards.

Tools used: 15mm socket

10. Adjust each of the pipes to ensure that all of the hanger pins are parallel with the frame mounted pins and that the rubber hangers are all positioned slightly forward. See **Figure 4**.

4. This allows the hangers to be properly positioned once the exhaust reaches operating temperature.

11. With the exhaust positioned properly, begin to evenly tighten the clamps starting with the ones closest to the front of the vehicle and working your way back. Torque the exhaust clamps evenly to 35 ft-lbs. Make sure that each slip is fully inserted within 1/4".

12. Remove the protective covering from the tailpipe tip.

**CAUTION:** The protective covering may ignite and burn if not removed prior to running the engine.

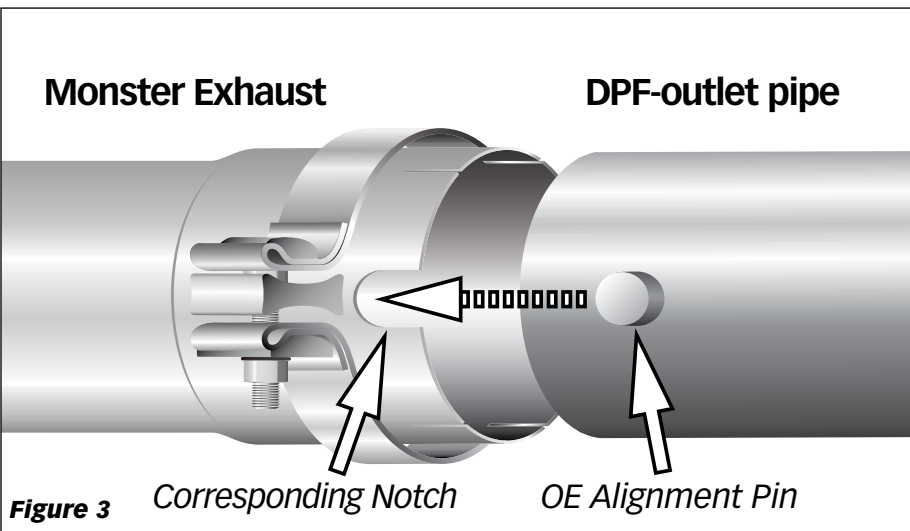

**Figure 3**

Corresponding Notch

OE Alignment Pin

**Figure 4**

*Hanger Angle Should Allow Pipe to Expand Toward Rear Of Vehicle*

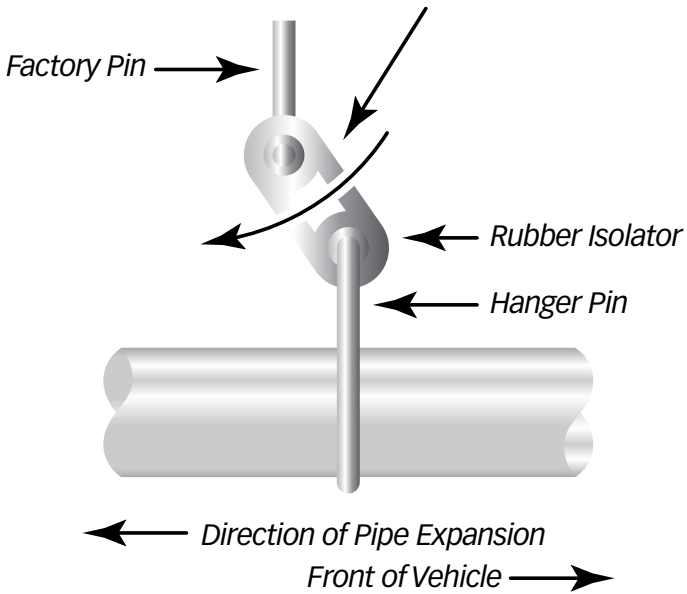

**13.** Re-connect the negative battery cable. Start the engine and listen for exhaust leaks. Tighten the exhaust clamps as necessary. Whenever possible, tack welding slip connections to prevent disengagement is recommended.

**14.** Your system includes two (2) Banks Power logos designed to complement the looks of your Ram truck. Position as shown in **Figure 5**.

**15.** The Banks Monster Exhaust installation is now complete.

**Figure 5**

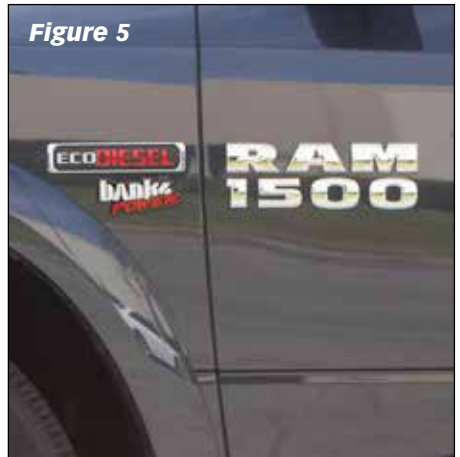

Gale Banks Engineering  
546 Duggan Avenue • Azusa, CA 91702  
(626) 969-9600 • Fax (626) 334-1743

Product Information & Sales: (888) 635-4565  
Customer Support: (888) 839-5600  
Installation Support: (888) 839-2700

**bankspower.com**