

BD r700 Race *Twin* **Turbo Kit**

1998 ½ - 2002 Dodge 24v ISB

Part# 1045420

PLEASE READ ALL INSTRUCTIONS BEFORE INSTALLATION.

** Picture as shown features recommended optional 3-piece HD Exhaust Manifold
(BD P/N# 1045985)*

UNLESS AN EO# IS LISTED, THIS PRODUCT IS LEGAL IN CALIFORNIA FOR RACING VEHICLES ONLY, WHICH MAY NEVER BE USED UPON A HIGHWAY.

BD Engine Brake Inc.
Plant Address: 33541 MacLure Rd. Abbotsford, BC, Canada V2S 7W2
U.S. Shipping Address: 88-446 Harrison St, Sumas, WA 98295 U.S. Mailing Address: P.O. Box 231, Sumas, WA 98295
Phone: 604-853-6096 | Fax: 604-853-8749 | Internet: www.bd-power.com

KIT CONTENTS :

Please check to make sure that you have all the parts listed in this kit before you start un-assembling of your truck.



DODGE 24V TWIN TURBO KIT (BD# 1045320)				
1405140-V2	1405217	1453119	1452985	
				
<i>R700 Primary Turbo (Un-wastegated)</i>	<i>Secondary Turbo (Wastegated)</i>	<i>R700 Primary Turbo Oil Drain</i>	<i>Secondary Turbo Oil Drain</i>	
Qty: 1	Qty: 1	Qty: 1	Qty: 1	
1453120	1453405P	1453600	1405237	1405229
				
<i>Primary Turbo Support Bracket</i>	<i>Primary Air Outlet Pipe</i>	<i>Primary Exhaust Outlet Pipe</i>	<i>5.5" Intake Clamp</i>	<i>Reducer Boot</i>
Qty: 1	Qty: 1	Qty: 1	Qty:1	Qty:1
1453602	1100740	1453700P	1453305P	
				
<i>Exhaust Down Pipe V-Band Clamp</i>	<i>4" Stainless Steel Down Pipe Clamp</i>	<i>Air Filter to Primary Turbo Pipe</i>	<i>Secondary Air Inlet Pipe</i>	
Qty: 1	Qty: 1	Qty: 1	Qty: 1	
1453502	1045986	1453110		
				
<i>Primary to Secondary Exhaust Pipe</i>	<i>Exh. Manifold Gasket Set</i>	<i>Primary Oil Drain</i>		
Qty: 1	Qty: 1	Qty: 1		

BD Engine Brake Inc.

Plant Address: 33541 MacLure Rd. Abbotsford, BC, Canada V2S 7W2

U.S. Shipping Address: 88-446 Harrison St, Sumas, WA 98295 U.S. Mailing Address: P.O. Box 231, Sumas, WA 98295

Phone: 604-853-6096 | Fax: 604-853-8749 | Internet: www.bd-power.com





2485012	1459122P
	
Large Single Volute Gasket	Intercooler Extension Pipe
Qty: 1	Qty: 1





r700 PRIMARY TURBO HARDWARE KIT (BD# 1453195)					
1452825	1452826	1453121	1453122	1453113	1453115
					
R700 Oil Drain Bolt (M10x1.5x25)	Oil Drain Washer (M10)	Pri. Support Bolt (M12x1.75x25)	Pri. Support Washer (M12)	Oil Drain Hose Clamps	Oil Feed Adapter (1/8MPT x -6JIC)
Qty: 2	Qty: 2	Qty: 1	Qty: 1	Qty: 2	Qty: 1

1453503	1453504	1462430	1462441	1405926 (0406)
				
Heat Shield	Zip Tie	Stud (M10x1.5)	Nut (M10x1.5)	Secondary Cast Elbow Down Pipe Clamp
Qty: 1	Qty: 3	Qty: 4	Qty: 4	Qty: 1





SECONDARY TURBO HARDWARE KIT (BD# 1453292)						
1453980	1453982	1453983	1604102	1604103	1453113	1453316
						
Turbo Mnt. Bolt (3/8NFx1.25)	Turbo Mnt. Nut (3/8NF Gold)	Turbo Mnt. Washer (3/8 Gold)	Lock Washer (8mm)	Bolt (M8x1x25)	Oil Drain Clamps	Spacer Plate
Qty: 2	Qty: 2	Qty: 4	Qty: 2	Qty: 2	Qty: 2	Qty: 1













TURBO HEAT SHIELD KIT (BD# 1459110)		
1459111	1459112	1459113
		
<i>Heat Wrap</i>	<i>Inner Wrap</i>	<i>S/S Wire</i>
Qty: 1	Qty: 1	Qty: 48"

HOSE & CLAMP KIT (BD# 1453492)				
1405222	1405221	1405213	1405211	1453701
				
<i>4"i.d. Hose (4" each)</i>	<i>3"i.d. Hose (4"/each)</i>	<i>Clamp (4.11")</i>	<i>Clamp (3.25")</i>	<i>Clamp (4")</i>
Qty: 2	Qty: 2	Qty: 2	Qty: 4	Qty: 2

1453130-B	1453112	1453161	1453162
			
<i>Oil Feed Hose (-6FJIC 90° x -6FJIC)</i>	<i>7/8" Upper Oil Drain Hose (4")</i>	<i>Primary Oil Inlet Adapter (-6JICMx-6JICF 90°)</i>	<i>Oil Feed Adapter (1/4MPT x - 6JIC)</i>
Qty: 1	Qty: 2	Qty:1	Qty:1

HEATER TUBE RETRO-FIT KIT (BD# 1453922)		
1459130	1459140	1300131
		
<i>Heater Tube Coupler</i>	<i>Heater Tube Clamp</i>	<i>Zap Strap</i>
Qty: 1	Qty: 1	Qty: 2

AIR BOX KIT (BD# 1453892)				
1453805T	2924	1453803	1453802	1453801
				
Air Box	Air Box Filter	Nut (1/4)	Washer (1/4)	Spacer
Qty: 1	Qty: 1	Qty: 3	Qty: 3	Qty: 1

24V Transmission Cooler Relocation Kit (BD# 1453184)					
1453118	1407030	1452816	1452817	1452818	1452819
					
Mounting Bracket	3 1/2" Band Clamp	7/16" x 3.5" Bolt	7/16" Flat Washer	7/16" Spring Washer	7/16" Nut
Qty: 2	Qty: 2	Qty: 2	Qty: 2	Qty: 2	Qty: 2
1604048M	1452820	1604049	1604054	1452821	
					
#8 MJIC x 1/4 MNPT	5/8" Barb Coupler	#8 FJIC x 1/2" Barb 45°	1/2" Transmission Hose	Gear Clamps	
Qty: 1	Qty: 1	Qty: 1	Qty: 96"	Qty: 10	
1300130	1604037	1604056		1400105	
					
Zap Straps	1/2" MNPT x 1/2" Barb	5/8" ID Heater Hose		3/8" MNPT x 1/2" Barb	
Qty: 12	Qty: 1	Qty: 74"		Qty: 1	

Pre-Installation

For the purpose of the instruction manual, the term “primary turbo” refers to the larger non-wastegated turbo and the term “secondary turbo” refers to the smaller wastegated turbo.

Installation should occur on a cold vehicle, as turbo and exhaust components become very hot with use.

The BD twin turbo system is recommended for trucks with 375-525 RWHP. We do have other kits available for higher horsepower. Please call us to discuss your options.

Also note that a stock transmission will not handle this power and torque, transmission modifications are a must.

Options

Description	Part #
BD 'X' Torque Converter	1070215X
BD Transmission	CALL
BD High Flow Injectors	CALL
BD Auxiliary Lift Pump Kit	1050226
BD High Flow Banjo Bolts	CALL
Heavy Duty Exhaust Manifold	1045985
BD X-Monitor	1085210
Head Studs	247-4202
BD High Pressure Intercooler Boots	1405220

When either upgrading or installing the twin turbo kit the wastegate will need to be adjusted. This wastegate is adjustable by turning the actuator rod. To adjust the wastegate you will need to unscrew the rod counter clockwise roughly 3 complete turns. You can then take the vehicle for a test drive to customize the boost pressure to the vehicle

YOU SHOULD EFFECTIVELY RUN AS MUCH BOOST AS POSSIBLE TO KEEP YOUR EGTS IN CONTROL <1200°F. PLEASE KEEP IN MIND EGTS ARE MORE DAMAGING TO HEAD GASKETS THEN BOOST PRESSURE IS.

BD Engine Brake Inc.

Plant Address: 33541 MacLure Rd. Abbotsford, BC, Canada V2S 7W2

U.S. Shipping Address: 88-446 Harrison St, Sumas, WA 98295 U.S. Mailing Address: P.O. Box 231, Sumas, WA 98295

Phone: 604-853-6096 | Fax: 604-853-8749 | Internet: www.bd-power.com

Battery Disconnect

Disconnect the negative terminals on both of the vehicle's batteries, and then disconnect the positive terminals.

Installation

1. Record radio settings and disconnect both battery terminals on both batteries.

2. If your vehicle heater feed tube runs below your exhaust manifold, you will need to drain the engine coolant into a clean container to be re-used later.

3. Lay a protective cover over the passenger side fender to eliminate any scratches.

4. Remove the air box assembly and intake tube from the inlet of the turbocharger.

5. Remove the two 13 mm bolts connecting the exhaust down pipe to the turbo flange.

6. Remove the cast aluminum elbow attached to the turbo compressor housing outlet. You will need to loosen the 'V' band clamp and the band clamp with a 7/16" deep socket. Be sure not to lose the orange o-ring from the aluminum elbow, as you will re-use the aluminum elbow assembly later.

7. Remove the black steel intercooler tube. You will need to loosen the band clamp on the intercooler using a 7/16" deep socket.

8. Remove the turbo oil feed line

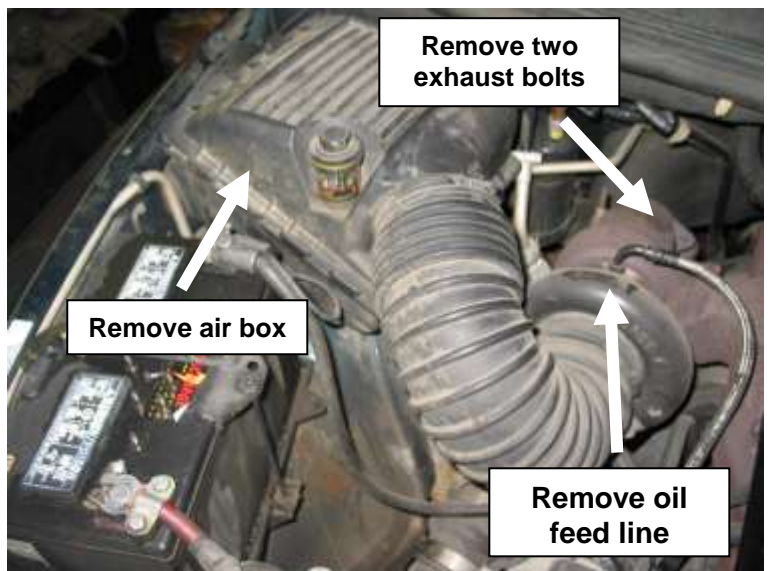

BD Engine Brake Inc.

Plant Address: 33541 MacLure Rd. Abbotsford, BC, Canada V2S 7W2

U.S. Shipping Address: 88-446 Harrison St, Sumas, WA 98295 U.S. Mailing Address: P.O. Box 231, Sumas, WA 98295

Phone: 604-853-6096 | Fax: 604-853-8749 | Internet: www.bd-power.com

(top of turbo) from the turbo by holding the 19mm turbo fitting with a wrench and remove the 13/16" line fitting – place line to the side. As well you may now remove the 19mm oil feed fitting.

9. Unbolt the turbo oil drain tube (bottom of turbo) by removing the two 10mm bolts.

10. Remove the lower hose clamp on the turbo oil drain boot and remove the oil drain tube and hose as an assembly - you will need the hose later.

11. Remove the four nuts holding the turbo to the exhaust manifold with a 15mm wrench—remove the stock turbo and set it aside.

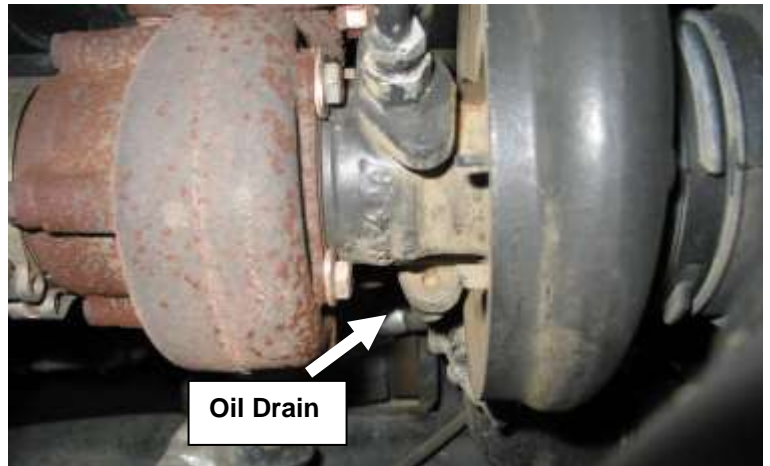

12. Remove the stock down pipe and intermediate pipe from the exhaust system.

13. Remove the nut holding the heater core line to the exhaust manifold stud using a 15mm socket, remove the spring clamps at each end of the steel line and remove the line.



14. Remove the exhaust manifold bolt retainer straps if equipped, and then remove the bolts with a 13mm socket. Remove the spacers and finally the manifold at this time. Be sure not to loose the spacers.

15. Discard all exhaust manifolds gaskets and clean then engine block and exhaust manifold mating surface.

**** Critical Step ****

16. On the lower right side of engine, 6" from the rear of the engine block (just above the oil pan), there is a frost plug that caps an oil drain port that leads to the engine crankcase. This frost plug needs to be removed to serve as the oil drain for the *primary turbo*.

BD Engine Brake Inc.

Plant Address: 33541 MacLure Rd. Abbotsford, BC, Canada V2S 7W2

U.S. Shipping Address: 88-446 Harrison St, Sumas, WA 98295 U.S. Mailing Address: P.O. Box 231, Sumas, WA 98295

Phone: 604-853-6096 | Fax: 604-853-8749 | Internet: www.bd-power.com

Great care needs to be taken when removing the frost plug so that it isn't forced into the oil pan.

The frost plug can be removed by coating a drill bit with grease (to catch any metal shavings) and by drilling a small hole in the center of the frost plug. Insert a sheet metal screw into the hole and pry the frost plug out with a pair of pliers.

Coat the lower portion of the supplied oil drain block adapter with Loctite or Anaerobic sealer and gently tap the spout into the block.



17. Reinstall the exhaust manifold in an **inverted manner** so the turbo flange faces upward. Use the provided manifold gaskets and the factory bolts, spacers and retainers and torque to 32 ft lbs with a 13mm socket.

Note: If you have purchased a heavy-duty aftermarket manifold, you will need to install it in the same inverted manner. Please consult the manifold's instructions for the rest of the installation.



Automatic Transmission Heat Exchanger Relocation

Standard transmissions can skip to the turbo preparation and installation section.

18. Locate the transmission heat exchanger located on the passenger side rear of the engine. It is roughly 9" long and 3" in diameter and painted black.
19. Disconnect the transmission oil cooler lines at the heat exchanger using a 7/8" wrench.
20. Disconnect transmission oil cooler line at the Driver's side front of the transmission using a 3/4" wrench. Then disconnect the 1/4" hose clamp connection under the driver's side underneath the radiator.
21. Remove transmission cooler lines, note that there will be plastic locking clips that secure the line to engine that will also need to be removed.
22. Disconnect the two coolant lines from the front of the heat exchanger. These connections are secured using spring clamps.

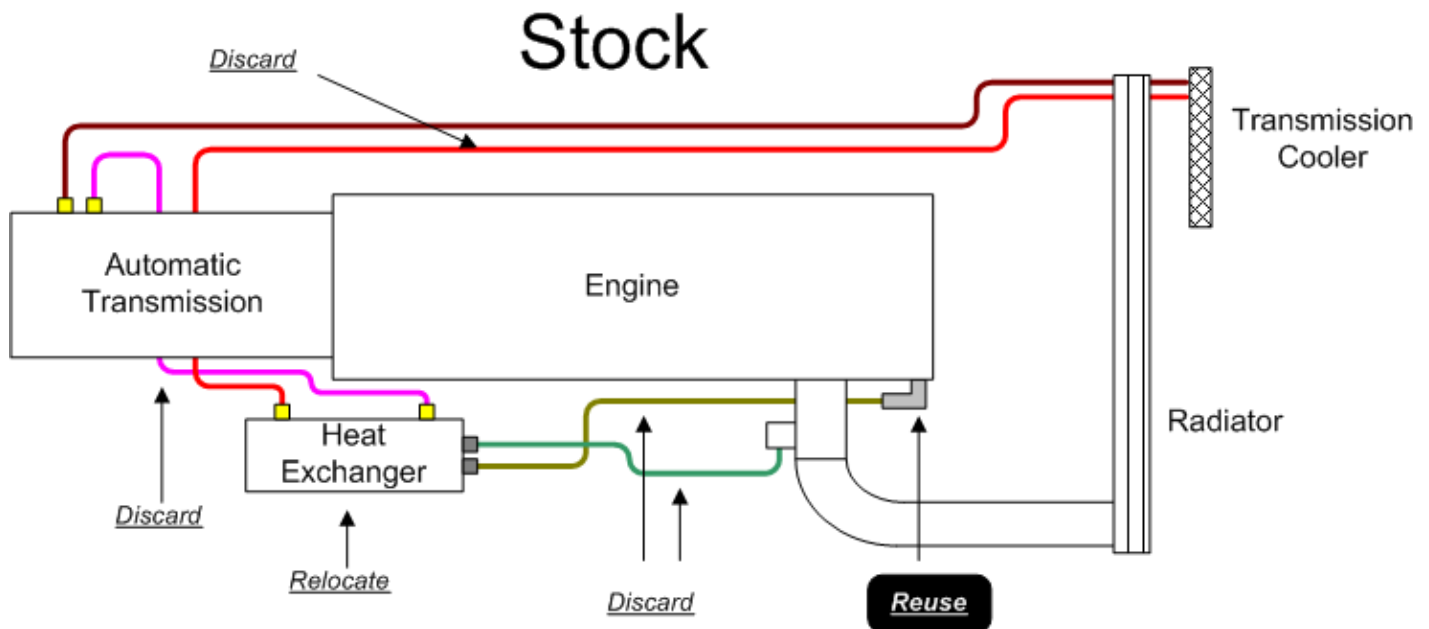

BD Engine Brake Inc.

Plant Address: 33541 MacLure Rd. Abbotsford, BC, Canada V2S 7W2

U.S. Shipping Address: 88-446 Harrison St, Sumas, WA 98295 U.S. Mailing Address: P.O. Box 231, Sumas, WA 98295

Phone: 604-853-6096 | Fax: 604-853-8749 | Internet: www.bd-power.com

23. Then disconnect the coolant line at the front passenger's side of the engine from the 90° rubber bend/elbow. Just loosen the hose clamp to release the hard line. Note that you will need to keep this 90° rubber bend/elbow in place.

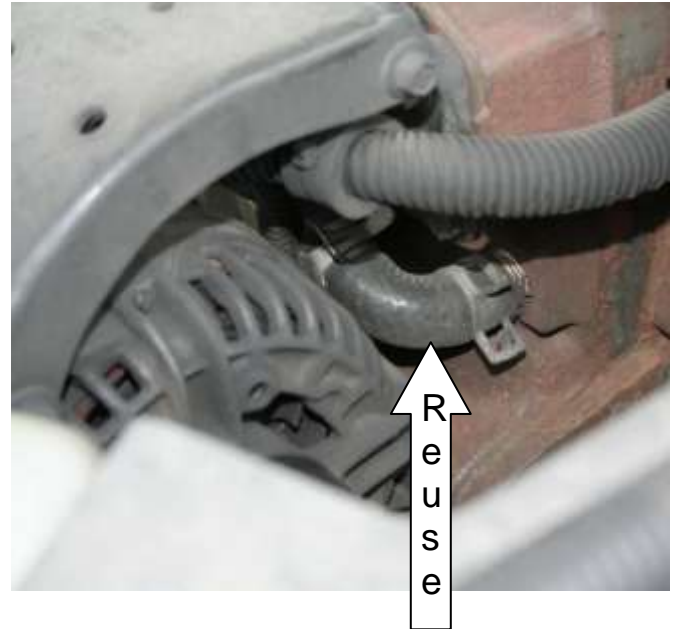

24. Also remove the coolant line at the side of the aluminum distribution block beside the lower radiator hose.



DO NOT REMOVE THE PASSENGER CAB HEATER CORE COOLANT LINE

25. Now locate the 4 mounting bolts for the heat exchanger, 2 on the bell housing and 2 on the engine. Use a 17mm wrench to remove the 4 bolts.

26. With the heat exchanger removed you will need to cut off the factory mounting brackets. You will obviously need to be careful as not to cut through the outer shell. Cut the weld sections of the bracket to the point they are flush with the OD of the heat exchanger. Paint the heat exchanger black to protect the unit against corrosion.

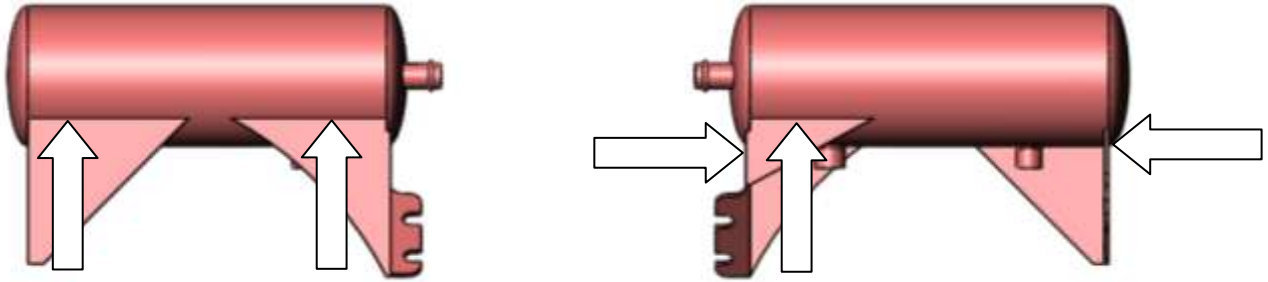

27. Before installing the heat exchanger, install the $\frac{1}{2}$ " MNPT x $\frac{1}{2}$ " barb fitting (1604037) into the NPT port closest to the coolant in and out ports. Be sure to use pipe sealant to seal the connection.

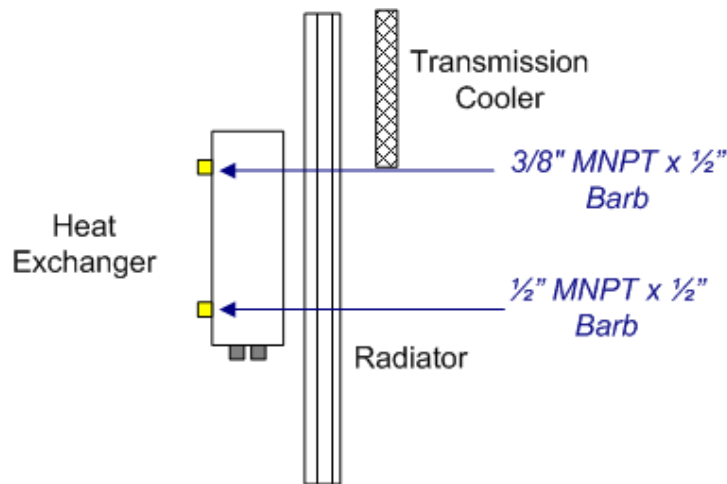

28. Now install the $\frac{3}{8}$ " MNPT x $\frac{1}{2}$ " barb fitting in the remaining NPT port. Be sure to use pipe sealant to seal the connection.
29. With the heat exchanger removed, locate the front cross member underneath the engine fan. This will be the new mounting location of the heat exchanger.
30. Using a drill, drill a $\frac{1}{2}$ " hole in this cross member from the rear of cross member towards the front of the truck. These holes should be roughly centered on the cross member and about 2.5" center to center.

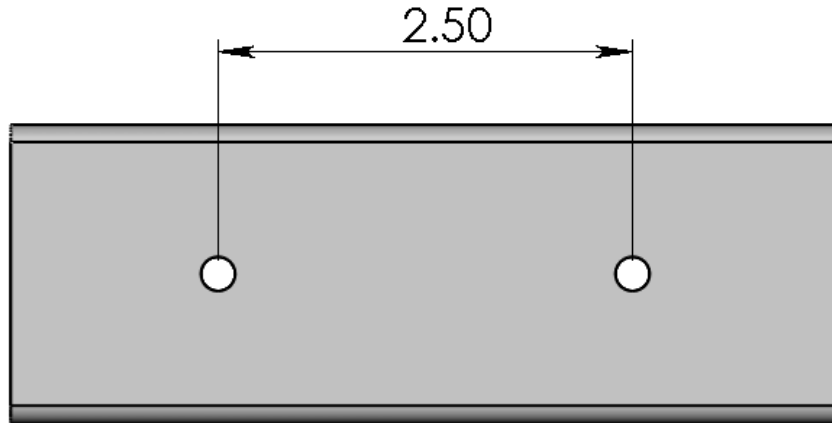

31. Then secure the two mounting brackets (1453118) to the cross member using the 7/16" mounting hardware (1452816, 1452817, 1452818, 1452819). Torque the bolts to 20 ftlbs. Note that the "windows" or rectangular clamp cutouts should be vertical.

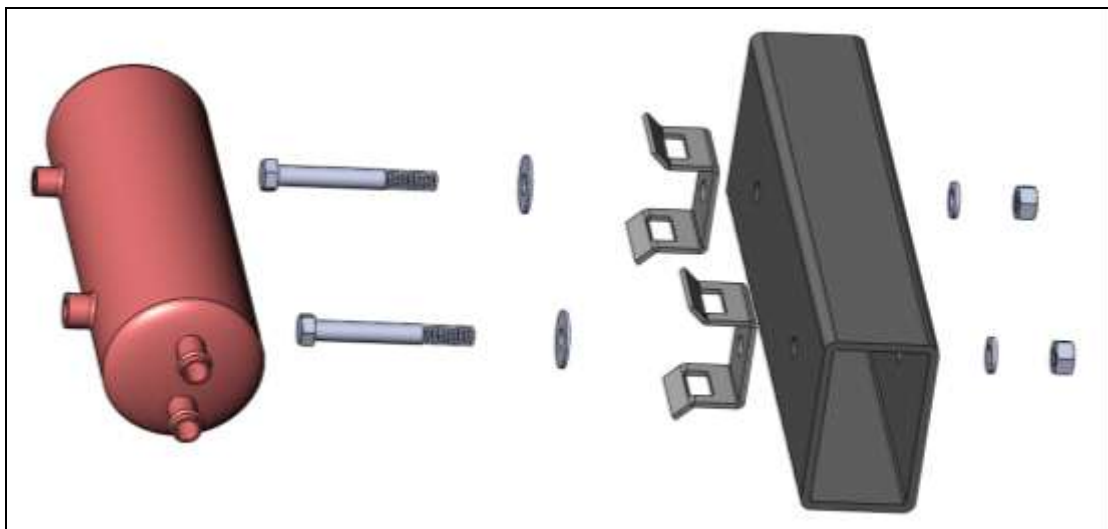

32. Unscrew the 3.5" band clamps (1407030) completely. Then remove the "Bridge" this will allow you to insert the clamp through the open "windows" on the mounting brackets.

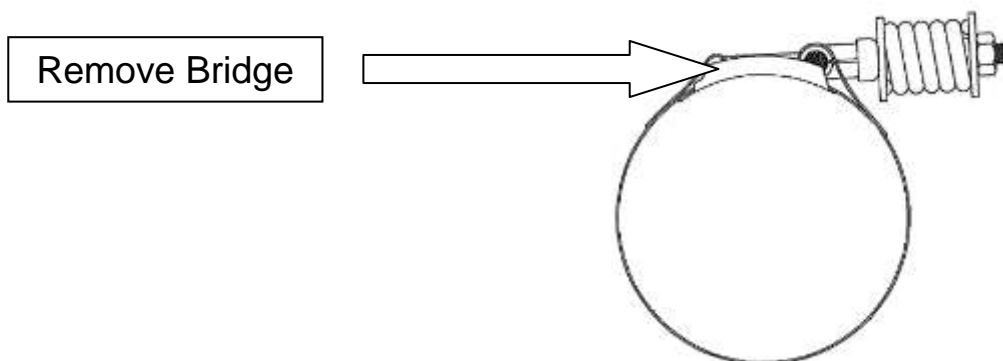

BD Engine Brake Inc.

Plant Address: 33541 MacLure Rd. Abbotsford, BC, Canada V2S 7W2

U.S. Shipping Address: 88-446 Harrison St, Sumas, WA 98295 U.S. Mailing Address: P.O. Box 231, Sumas, WA 98295

Phone: 604-853-6096 | Fax: 604-853-8749 | Internet: www.bd-power.com

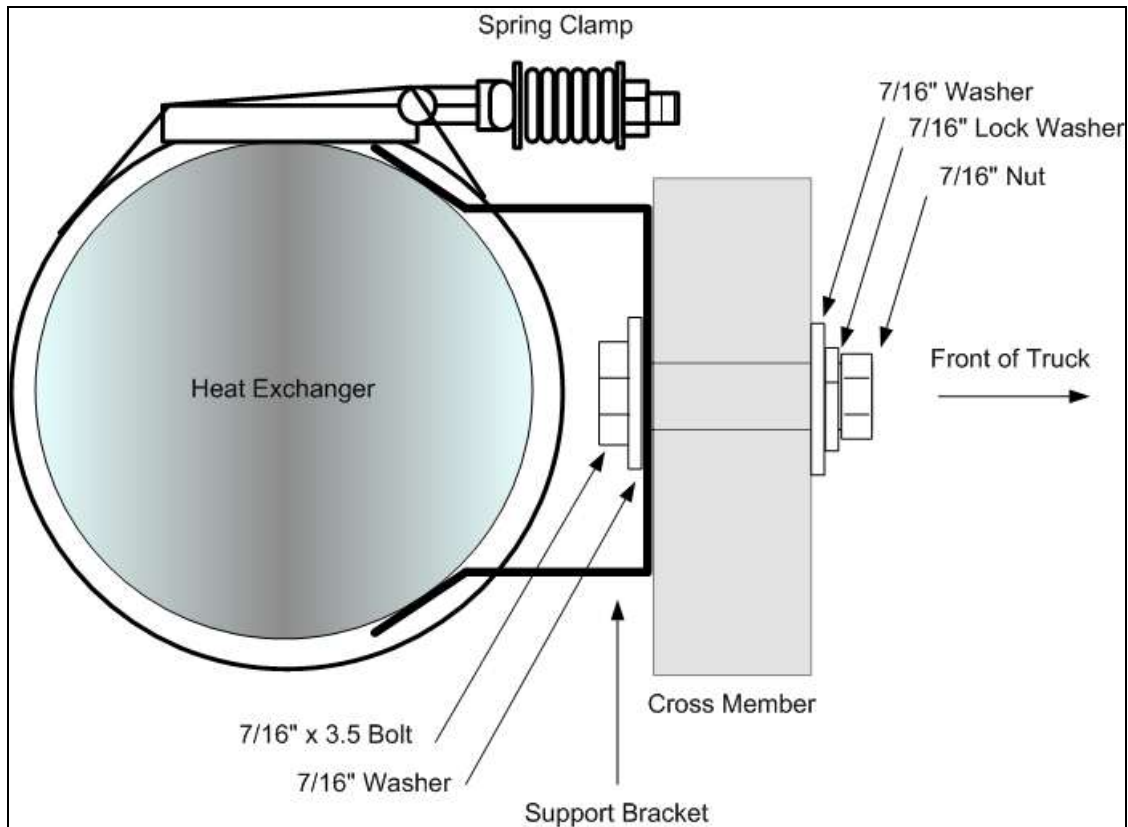

33. Once the two clamps have been inserted through the two windows on each bracket you can lift the heat exchanger into place. Wrap the band clamps around the heat exchanger and tighten to **30inlbs**. Note that the water inlet/outlet should be placed on the passenger side. With the oil inlet/outlet pointing towards the rear of the vehicle.
34. With the heat exchanger mounted you can now route the selected hoses.

$\frac{1}{2}$ " ID Black Hose = Oil
$\frac{5}{8}$ " ID Black Hose = Coolant

All the OIL (Blue Hose) lines will run along the Driver's side of the vehicle, while the COOLANT lines (Black Hose) should run along the passenger's side of the vehicle.

Altered

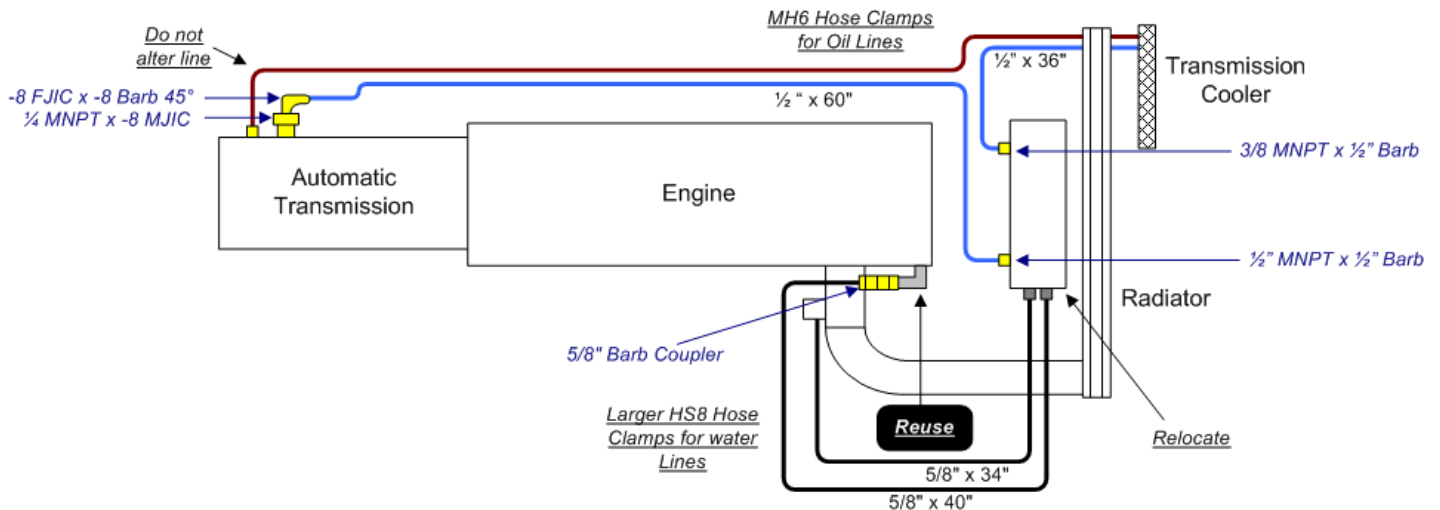

Using the 90° formed rubber hose that you saved earlier, install it on the passenger side front of the engine cylinder head. Secure the connection using a HS8 clamp. On the other side of the rubber 90° insert the 5/8 barb coupler (1452820). Secure the connection with another HS8 clamp.

You can now insert the coolant hose onto the 5/8 barb coupler and route the hose towards the front and to the relocated heat exchanger. You should use roughly 40" for this operation, but trim for the best fit. Secure all connections using the HS8 clamps.

Now using the 34" of coolant hose leftover, connect one side to the coolant discard elbow on the front of the engine, mid level passenger side. Secure this connection with a HS8 clamp.

Route the coolant hose to the heat exchanger mounted at the front, connect the hose to the last coolant connection and secure using a HS8 hose clamp. Trim excess hose. Secure all loose hose points with zap straps.

THERE ARE A NUMBER OF POTENTIAL CHAFING POINTS FOR THE COOLANT HOSE. EACH APPLICATION WILL BE SLIGHTLY DIFFERENT FOR THESE LOCATIONS.

YOU CAN DOUBLE WRAP THE HOSE AT THESE POINTS TO PROVIDE TWICE THE PROTECT. SECURE THE DOUBLE WRAP USING THE PROVIDED ZAP STRAPS.

BD Engine Brake Inc.

Plant Address: 33541 MacLure Rd. Abbotsford, BC, Canada V2S 7W2

U.S. Shipping Address: 88-446 Harrison St, Sumas, WA 98295 U.S. Mailing Address: P.O. Box 231, Sumas, WA 98295

Phone: 604-853-6096 | Fax: 604-853-8749 | Internet: www.bd-power.com

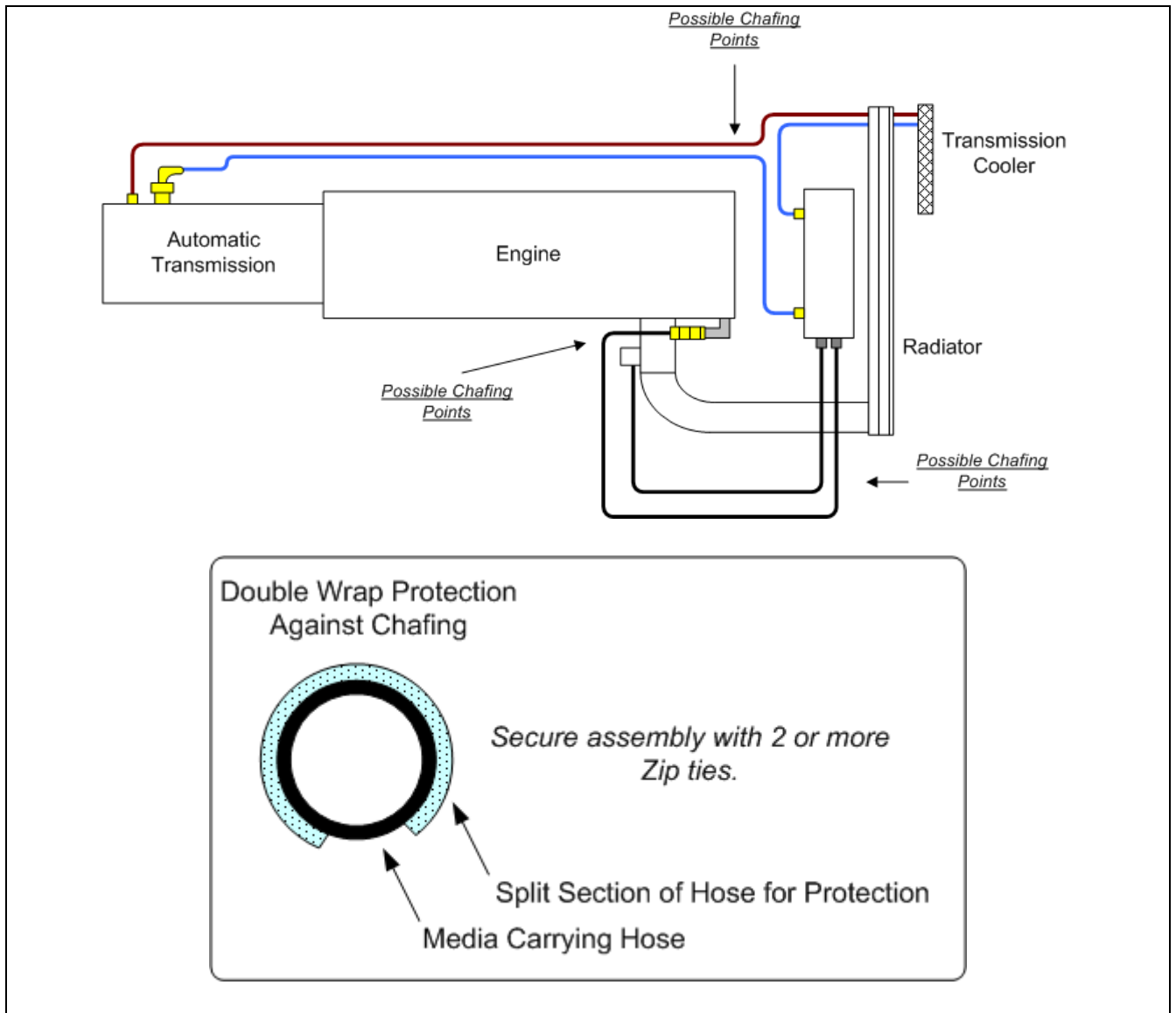

You can now start on routing the transmission oil lines. First connect the $\frac{1}{4}$ MNPT x -8 MJIC (1604048M) fitting to the transmission cooler port on the driver's side of the transmission. Use a small amount of pipe sealant on this application, thread the fitting in by hand and then using a wrench give it one more turn and no more. **Do not over torque.**

Then install the -8JICx $\frac{1}{2}$ " Barb 45° fitting onto the NPT fitting you just installed. Tighten the fitting; be sure not to allow the NPT fitting to turn while doing this.

Connect the $\frac{1}{2}$ "ID transmission oil hose to this new barb connection and secure using the MH6 Hose clamp. Route the hose alongside the motor towards the front of the vehicle towards the newly mounted heat exchanger.

Trim hose to correct length (roughly 60") and install hose onto the $\frac{1}{2}$ "MNPT x $\frac{1}{2}$ " barb fitting. Secure using MH6 clamp.

BD Engine Brake Inc.

Plant Address: 33541 MacLure Rd. Abbotsford, BC, Canada V2S 7W2

U.S. Shipping Address: 88-446 Harrison St, Sumas, WA 98295 U.S. Mailing Address: P.O. Box 231, Sumas, WA 98295

Phone: 604-853-6096 | Fax: 604-853-8749 | Internet: www.bd-power.com

With the remaining section of hose, install on the 3/8"MNPT x 1/2" barb and secure with a MH6 clamp. Then route this connection to the transmission cooler spout that you removed a hose from earlier. Trim excess hose and secure this connection using a MH6 hose clamp. Tie up and loose hose using the provide zap straps.

THERE ARE A NUMBER OF POTENTIAL CHAFING POINTS FOR THE TRANSMISSION OIL HOSE. EACH APPLICATION WILL BE SLIGHTLY DIFFERENT FOR THESE LOCATIONS.

YOU CAN DOUBLE WRAP THE HOSE AT THESE POINTS TO PROVIDE TWICE THE PROTECT. SECURE THE DOUBLE WRAP USING THE PROVIDED ZAP STRAPS.

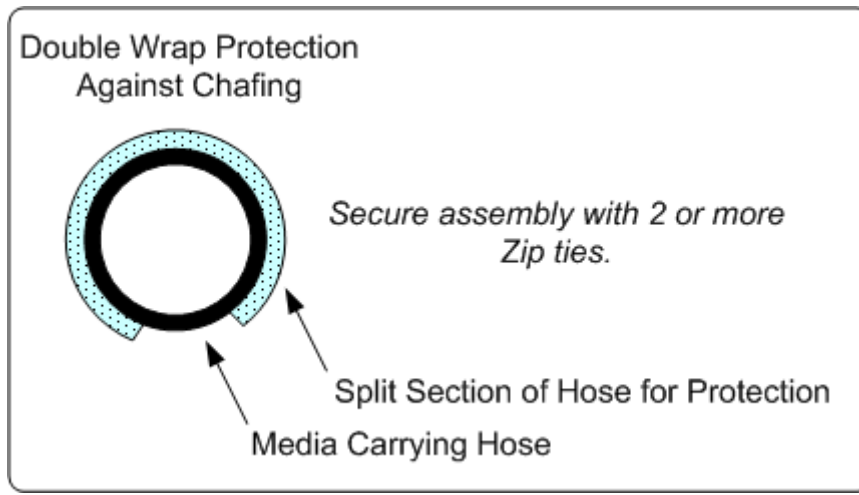
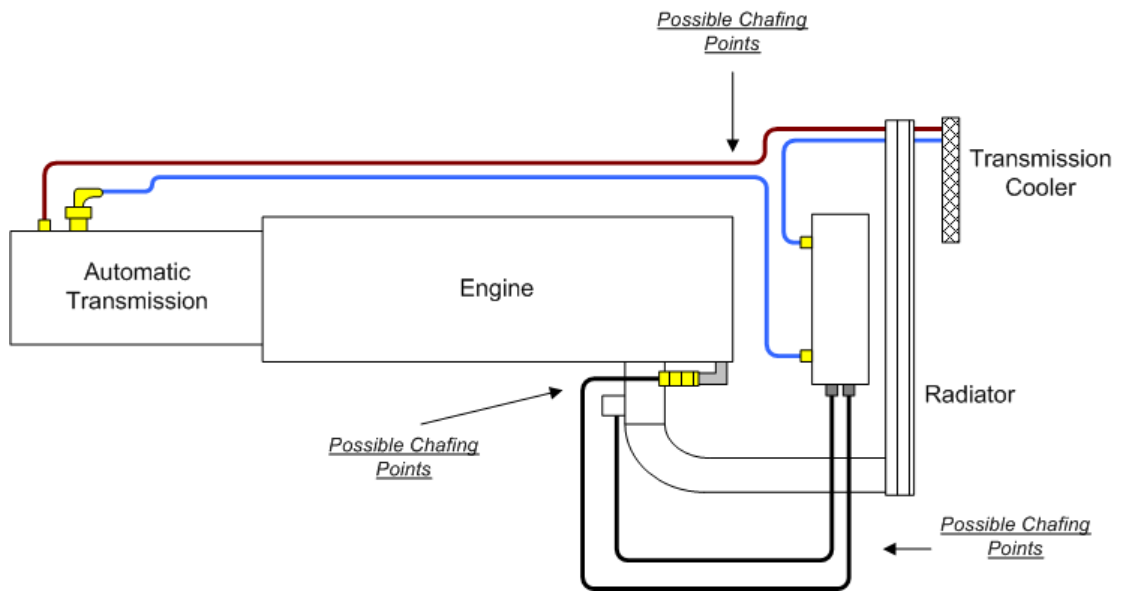

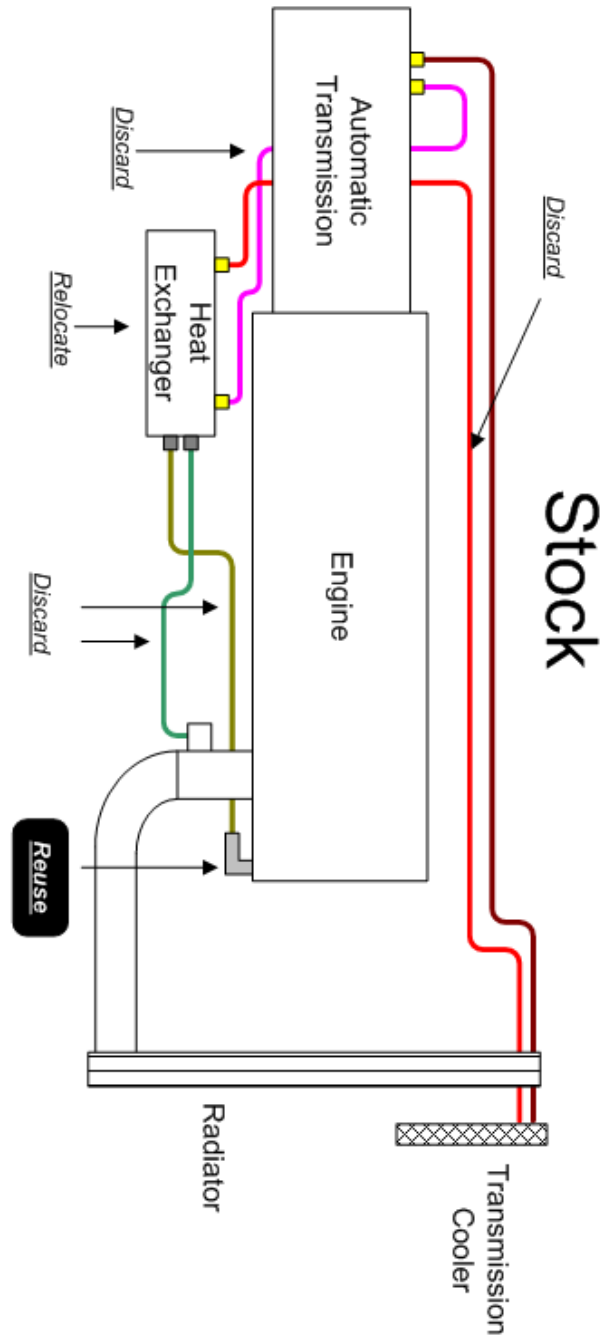

Altered

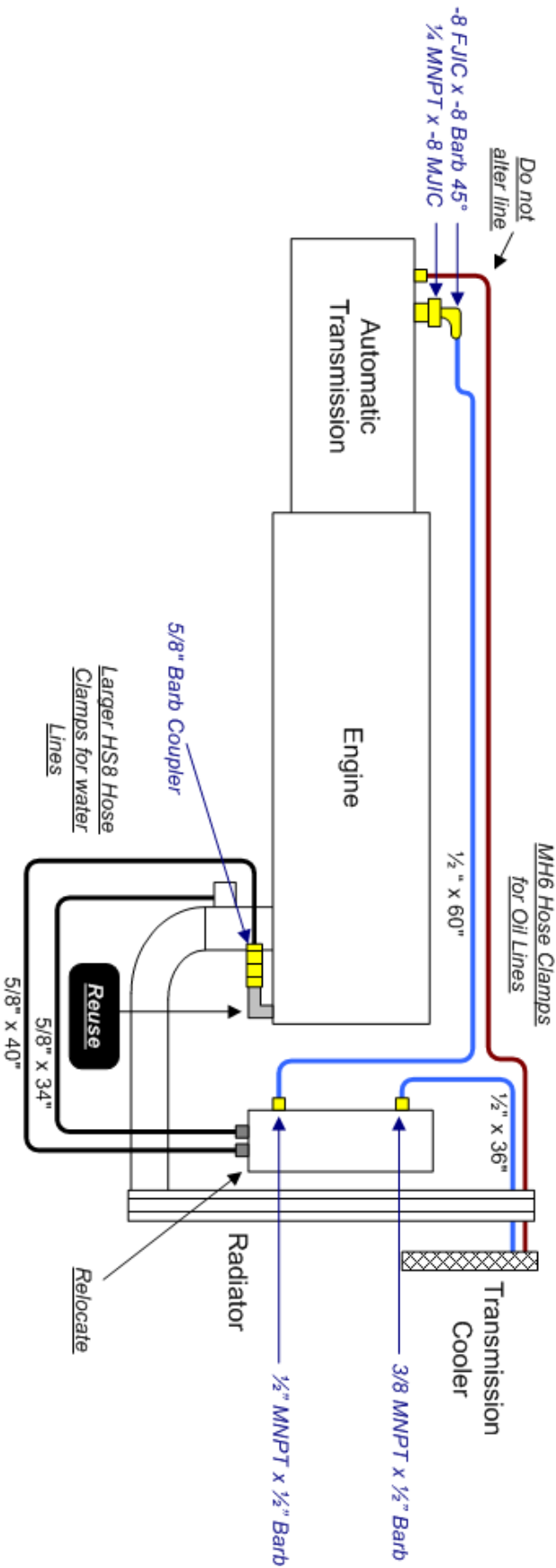

Turbo Preparation & Installation

To alleviate any fit problems, all turbocharger support bolts, housing bolts and clamps must be loose. Once everything has fit together, then tighten all bolts.

35. Remove the primary and secondary turbos from their boxes and remove any paper that may be in the inlets or outlets. It is critical that nothing is left inside of the turbos.
36. On the larger primary turbo non wastegated (#1405135) remove the brass 90° flare fitting from the oil inlet. Locate the supplied 1/4MPT x -6JICM fitting (1453162), apply a very small amount of pipe sealant on the threads (DO NOT USE TEFLON TAPE). Now thread the fitting into the oil inlet, hand tighten then using a wrench turn the fitting ½ turn. DO NOT OVER TIGHTEN.

37. On both turbos, loosen the 4 bolts that secure the exhaust turbine housing to the turbo body with a 13mm wrench.

Then, loosen the 8 bolts that are securing the turbo compressor housing to the CHRA with a 13mm wrench. This will allow the two housings to rotate freely. Be careful not to loosen the housings off too much as they will fall off and possibly damage the turbo wheels. The clamps should only be loose enough to clock the housings.

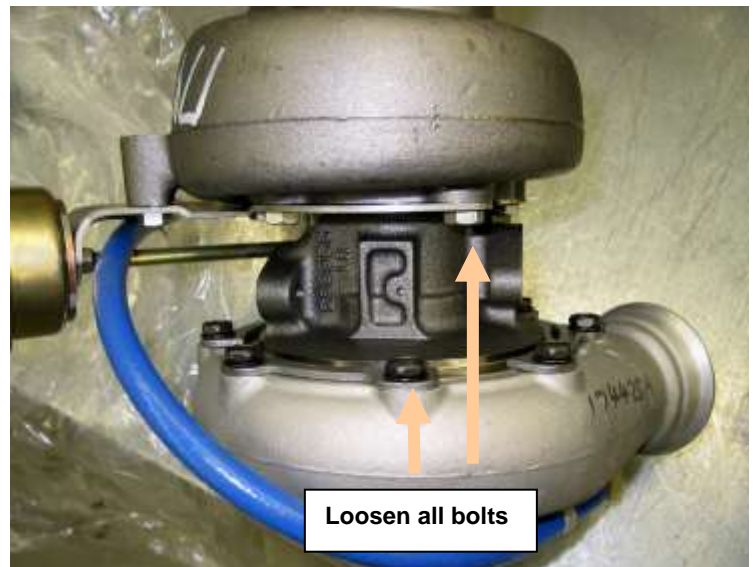

38. Thread the previously uninstalled OEM 19mm oil feed adapter into the *secondary turbo*. This is the adapter that you remove from the factory turbo.

39. Install the long oil drain adapter onto the bottom of the *secondary turbo* with the supplied gasket and two 8mm X 25mm bolts and lock washers with a 13 mm socket.



BD Engine Brake Inc.

Plant Address: 33541 MacLure Rd. Abbotsford, BC, Canada V2S 7W2

U.S. Shipping Address: 88-446 Harrison St, Sumas, WA 98295 U.S. Mailing Address: P.O. Box 231, Sumas, WA 98295

Phone: 604-853-6096 | Fax: 604-853-8749 | Internet: www.bd-power.com

40. Install the short oil drain adapter onto the bottom of the r700 *primary turbo* with the supplied gasket and two M10x1.5x25 bolts and M10 lock washers.

**** Critical Step ****

41. Squirt fresh oil down the oil feed port of both turbochargers while slowly rotating the compressor wheel.

42. Remove the 1/8 NPT plug using a 7/16" wrench from the top of the oil filter head and install the supplied oil feed adapter fitting (#1453115).

43. Mount the *secondary turbo wastegated turbo* (#1405217) to the exhaust manifold.



Installing with Stock Manifold

Mount the turbo to the manifold using the two factory studs and nuts, the supplied gasket, two 3/8" X 1-1/2 NF bolts, two 3/8" nuts and the four 3/8" flat washers. You will need to use two separate 9/16" wrenches.

Installing with Aftermarket Manifold

Remove the studs from your stock turbo and stock manifold for reinstallation into your aftermarket Heavy Duty Manifold. Install the turbo with the gaskets on either side of the spacer plate and reuse the factory mounting nuts. Note the stainless spacer will only need to be installed between the turbo and manifold if you are using an ATS aftermarket manifold..

44. Locate the cast flanged turbine adapter, and wrap the supplied heat shielding around the adapter. The heat shield has been formed in a specific pattern to completely wrap around the elbow. Use the 3 supplied stainless steel zip ties to secure the heat shield. One at the bottom, one at the middle and one at the top. Be sure that neither the heat shield



BD Engine Brake Inc.

Plant Address: 33541 MacLure Rd. Abbotsford, BC, Canada V2S 7W2

U.S. Shipping Address: 88-446 Harrison St, Sumas, WA 98295 U.S. Mailing Address: P.O. Box 231, Sumas, WA 98295

Phone: 604-853-6096 | Fax: 604-853-8749 | Internet: www.bd-power.com

or zip tie will interfere with the circular marmon flange when the band clamp is applied.

45. You can now bolt the flanged turbine adapter to the primary turbo. Use the four M10x1.5 studs and serrated nuts to secure the adapter pipe to the turbo. At the same time mount the SS primary turbo support bracket to the assembly.

Note that the support bracket bolts on the bottom side of the turbine housing.

It will also save you a lot of time if you install the primary oil feed line at this time. Thread the 1453130 line into the flare fitting on the turbo. Be sure to orientate it in the correct direction.

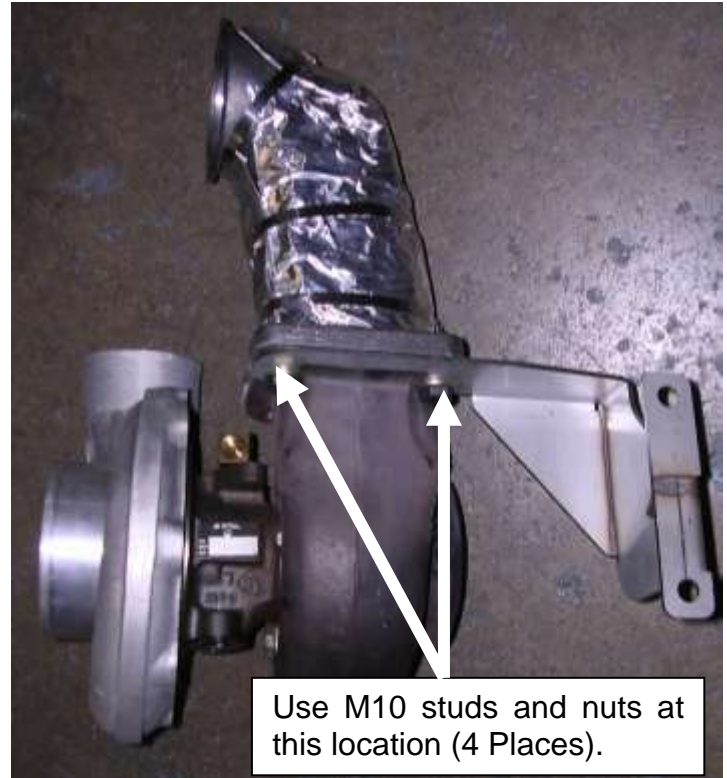

46. Place the turbo and turbine adapter assembly onto the frame rail in a location close to the final install point. Be sure that it does not fall.



47. With the secondary turbo, bolt it loosely to the manifold and align the oil inlet straight up and the compressor outlet towards the bottom of the passenger battery.

BD Engine Brake Inc.

Plant Address: 33541 MacLure Rd. Abbotsford, BC, Canada V2S 7W2

U.S. Shipping Address: 88-446 Harrison St, Sumas, WA 98295 U.S. Mailing Address: P.O. Box 231, Sumas, WA 98295

Phone: 604-853-6096 | Fax: 604-853-8749 | Internet: www.bd-power.com

48. Using the supplied v-band clamp (clamp will be labeled 995L2-0406) tighten the secondary exhaust housing to the primary turbo-turbine adapter assembly.

Make sure that heat shield or stainless zip tie does not interfere with the band clamp. Tighten the v-band clamp just enough so that you can still rotate the exhaust elbow.

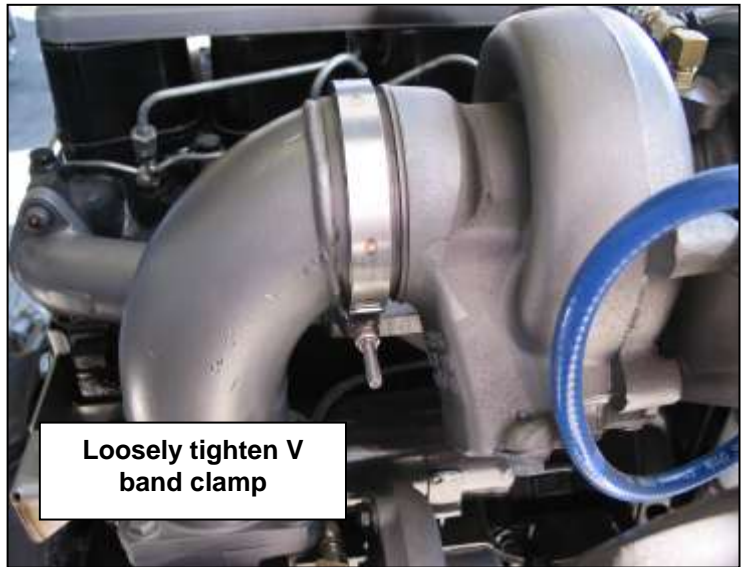

49. Install the *primary turbo* support bracket to the engine block with the supplied bolt (12mm x 1.75 x 25) and lock washer. Now tighten the bolts and V band clamp.

50. Now that the exhaust housings are in their proper locations, the turbo center sections can be twisted so that the turbo oil feeds are pointing up (+/- 12°) and drains are pointed at the block adapters. Tighten the exhaust housing bolts. Note that you may adjust the factory block oil drain adapter to help align the system.

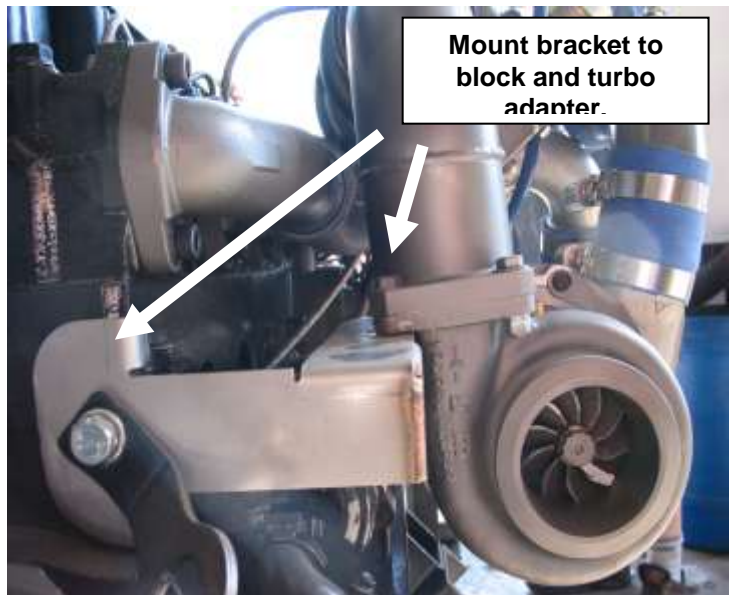

51. Install the short piece (approximately 4") of 7/8" hose that we have provided to the *primary turbo* drain tube to the block adapter. You will need to apply a little lube to the hose to fit over the adapter.

52. Discard the factory oil drain hose and use the supplied 4" section on the *secondary turbo* drain. This hose will attach to the factory drain adapter. Use the hose clamps to secure the connection. You will need to slide the oil drain adapter as far as possible away from the wastegate



arm to prevent any contact. In some rare cases the wastegate arm may need to be bent.

53. If your heater feed tube runs below your exhaust manifold, remove it and cut off the support bracket in half as shown. Clean off the powder coat and loosely install the brass coupler and reinstall the line with original hose clamps. This will allow you to position the rearward end between the turbo and manifold and hook it back up to the factory rubber hoses. Once positioned, tighten the brass coupler and install the new support clamp to the oil filter housing bolt. Zap strap the two rubber heater hoses to secure them together.



54. Install the factory oil feed line into the 19mm oil feed adapter that should be installed in the *secondary turbo* (hold the fitting with a 19mm wrench and tighten the line with a 13/16" wrench), this line should run on the engine side of the turbo.

55. Install the *primary turbo* oil feed line (#1453130-B) to the primary turbo oil inlet fitting. Then connect the other end of the oil feed line to the 1456161 90° JIC adapter. This adapter should be connected to the 1453115 fitting that you installed into the oil filter block earlier.

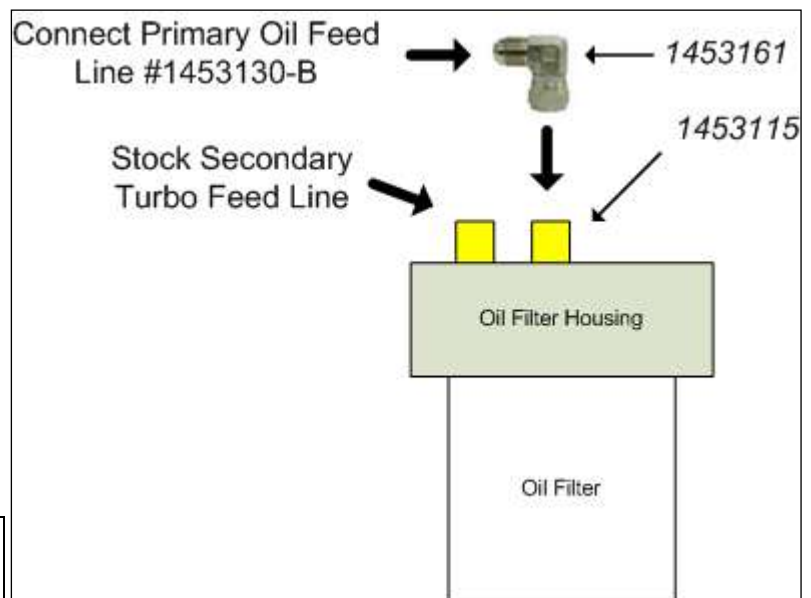

NOTE: All oil drains and feeds should be vertical (+/- 12°).

56. Remove the factory intercooler horn and boot from the factory intercooler pipe and place them on the new intercooler pipe provided.
57. Install the cast aluminum elbow and intercooler tube assembly to the compressor outlet of the *secondary turbo* and the lower intercooler boot. Secure with the factory v-band clamp and the two boot band clamps (use a 7/16" deep socket to tighten all clamps)

Be sure not to forget to install the orange factory o-ring in the cast elbow joint from the compressor housing to the intercooler elbow. Then tighten the compressor housing bolts.

58. The compressor housing of the *primary turbo* should still be loose and so adjustments can be made as required. Move the compressor housing around so that the fit is secure and the tubes will not hit anything when the engine torques over.
59. Install the 4" x 5.5" silicone reducer boot onto the intake of the r700 primary. Secure the 5.5" turbo side with the provided 6" gear clamp.

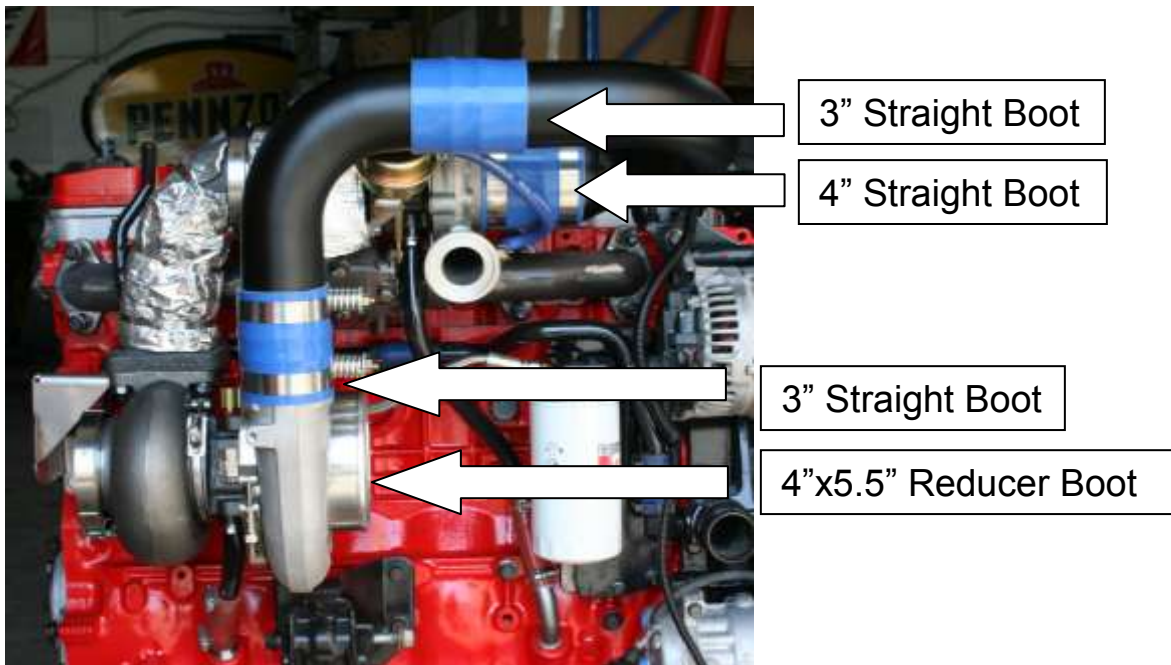

60. Install one 4" silicone boot on the *secondary turbo* compressor housing inlet. Slide two heavy duty 4" spring band clamps (4.11) at the same time, you will need to completely loosen the nuts to do this.

You can discard the 2nd 4" silicone boot.

61. Install a 3" silicone boot on the compressor outlet of the *primary turbo* and slide two Heavy Duty 3" band clamps (3.25) onto the boot.

62. Slide the 90-degree steel pipe (1453405P) into the compressor outlet boot on the *primary turbo* and



point the pipe outlet towards the front of the vehicle.

63. Install a 3" silicone boot on the 3" 'U' 180° pipe (1453305P) and slide two Heavy Duty 3" band clamps (3.25) onto the boot and install it between the short 90° on the primary to the secondary turbo 4" inlet.
64. Once all intermediate pipes are lined up, the heavy-duty hose clamps can be tightened as well as the bolts on the *primary turbo* compressor housing.
65. Loosely secure the new down pipe to the *primary turbo* using the supplied V-band clamp.

Be sure to align all exhaust pipes, and then tighten the V band clamp on the back of the turbo. Once this is done you can finally clamp and weld the appropriate exhaust components.

66. In each kit there is a 17" section of silver exhaust wrap, along with a 16" tan section. You will need to stack these two pieces of wrap on top of each other, so that the silver wrap can be folded over the tan wrap on all four sides.

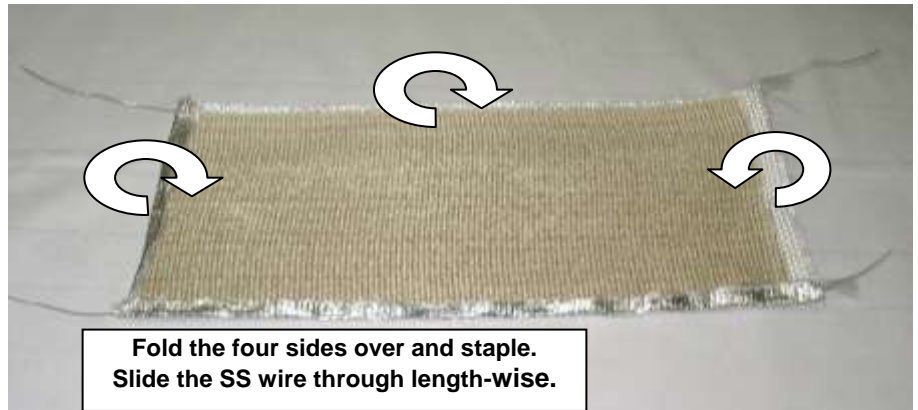

Note that the silver side should be facing out, so that the tan wrap is fixed against the white side of the wrap. You will need to staple all four folds to secure them in place. Once secure, run the 40" stainless wire through the folds length-wise. You will need to do this on both sides.

67. Install the turbo heat shield as shown over the top of the secondary turbo exhaust housing and secure with the stainless wire. Completely wrap the blanket around the turbo housing, then tighten and tie off with the stainless steel wire.



68. Install the air box spacer on the stud at the front closest to the engine. This stud is lower than the other two.

69. Insert the 4" intake tube (1453700P) into the air box and then into the 4"x5.5" silicone boot in the compressor inlet of the *primary turbo*. Secure the turbocharger connection with a 4" gear clamp (1453701). Discard the second 4" gear clamp.
70. Install air box onto the factory studs using the three supplied 1/4" NF nuts and the three supplied 1/4" flat washers.
71. Using a 7/16 deep socket tighten the two band clamps on the silicone boots – ensure all pipes have good contact with the boots and at least 1/8" of silicone sticks out past each clamp.
72. Install the supplied air filter by inserting it onto the pipe after it has passed through the air box and secure it with the supplied 4" hose clamp.
73. Re-connect the battery terminals and refill engine coolant. Double check all connections to make sure that they are all secure and free from any damage. You now may start the vehicle, once the vehicle has start and is up to temperature re-check for leaks and ensure that all the air is out of the coolant system.



Note: The exhaust housings of the turbos may smoke slightly when new, as manufacturing residue on housing must burn off.

Twin Turbo Testing

It is highly recommended that allow the turbochargers to break in, before any high power test runs. Slowly allow the turbo to come up to boost.

While driving listen for any odd noises such as a boost leak or perhaps piping rubbing against the vehicle. Once the vehicle has gone through a number of heat cycles it is highly suggested to retighten all clamps, bolts and nuts.

Periodically retighten all clamps and check for any oil or boost leaks.

IMPORTANT When idled for any length of time some oil may leak from the turbo. If the performance/boost is satisfactory and the wheel is not touching the housing (There will be some small movement), the excess oil is not a concern. Simply wipe with a clean cotton cloth and continue use.

Wastegate Adjustments

YOU WILL NEED TO ADJUST THE WASTEGATE!!!

The wastegate should be set to the maximum boost pressure possible. Close the wastegate and use the fueling box to control maximum boost. This combination will produce better fuel efficiency and cooler EGTs. If you still cannot control your boost you may need to look to a bigger set of twin turbos. Use the wastegate as a last resort.

It is better to have the wastegate closed as much as possible rather than open. If you are producing too high of boost pressure you will need to adjust your fueling to control the boost (either mechanically or electronically). Use the waste gate as a last resort.

DO NOT SET THE WASTEGATE TO OPEN AT 40PSI AND WHILE RUNNING 55PSI MANIFOLD PRESSURE (EXAMPLE ONLY). THIS WILL OVERLOAD THE PRIMARY CHARGER AND HURT YOUR TOTAL ACHIEVABLE HORSEPOWER. ONCE AGAIN CLOSE THE WASTEGATE, THE TURBOCHARGERS WILL RUN MORE EFFICIENT.

The wastegate is adjustable by turning the actuator rod. For more boost pressure you will need to tighten/shorten (clockwise) the waste gate rod for less boost pressure you can loosen the rod/lengthen (counter clockwise). The turning effect preloads the wastegate actuator spring. This adjustment is very finicky, be very careful, as you should not have to adjust the rod all that much. Make sure you are running enough boost for your horsepower requirements. If you have any questions or concerns call us.

**BD WILL NOT BE RESPONSIBLE FOR ANY FAILURES OF THE VEHICLE'S
HEAD GASKET.**

BD Engine Brake Inc.

Plant Address: 33541 MacLure Rd. Abbotsford, BC, Canada V2S 7W2

U.S. Shipping Address: 88-446 Harrison St, Sumas, WA 98295 U.S. Mailing Address: P.O. Box 231, Sumas, WA 98295

Phone: 604-853-6096 | Fax: 604-853-8749 | Internet: www.bd-power.com

To adjust the wastegate you will need to remove the rod end circlip first.

Then loosen the jam nut.

Apply air pressure to diaphragm. The actuator will then stroke, at this time lift up on the rod end and it will release from wastegate lever cylinder.

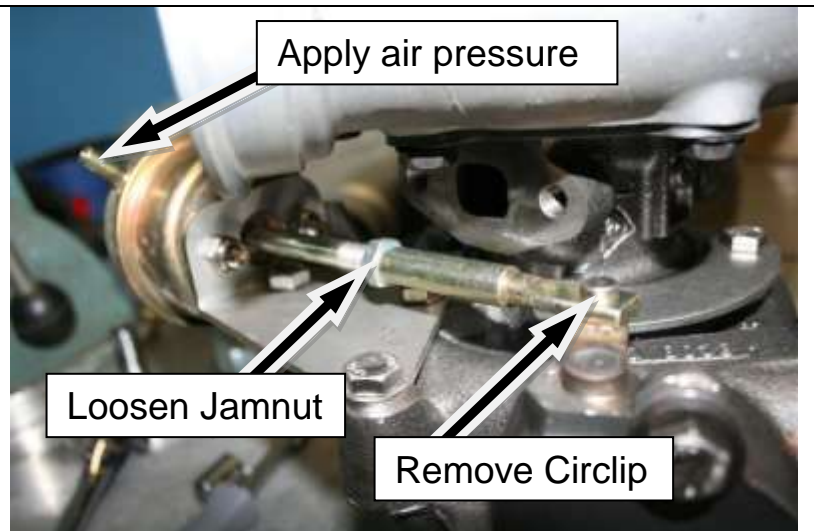

Shorter Rod = Higher Opening Pressure = Higher Boost

Longer Rod = Lower Opening Pressure = Lower Boost

Turn rod end to adjust wastegate opening pressure.

Shorter Rod = Higher Opening Pressure

Longer Rod = Lower Opening Pressure

We recommend the wastegate be almost closed off completely. Again use your fueling to control your boost level not your wastegate.

To re-install do the reverse of step 1.



BD Engine Brake Inc.

Plant Address: 33541 MacLure Rd. Abbotsford, BC, Canada V2S 7W2

U.S. Shipping Address: 88-446 Harrison St, Sumas, WA 98295 U.S. Mailing Address: P.O. Box 231, Sumas, WA 98295

Phone: 604-853-6096 | Fax: 604-853-8749 | Internet: www.bd-power.com