

1988-2002 Dodge Cummins **BD Turbo Mount Exhaust Brake**

Part Number	Application
2033135	1988-1998 Dodge Cummins 12V (Micro Switch)
2033137	1999-2002 Dodge Cummins 24V (DFIV)

Serial # _____

Date Purchased _____

Purchased from _____

Installed by _____

***** Please read this manual before starting installation. *****

OWNER'S MANUAL - LEAVE IN GLOVE BOX

TABLE OF CONTENTS

Welcome.....3

Kit Contents3

Pre-Installation.....4

Special Tools Required5

Accessories5

Notes On Connectors5

Stock Turbo Configuration Diagram6

BRAKE VALVE INSTALLATION7

 1988 to 1993 Dodge Cummins7

 1994 to 1998 Vehicles7

 1998½ to 2002 Vehicles7

SPOOL VALVE INSTALLATION8

 1988 to 1993 Vehicles8

 1994 to 2002 Vehicles8

VACUUM SUPPLY.....8

 1988 to 1996 vehicles with vacuum power brakes.....8

 1997 to 2002 Vehicles9

 1997 to 2002 vehicles with hydroboost power brakes.....10

THROTTLE SWITCH INSTALLATION (1988-1998 Vehicles)11

 1988 to 1993 vehicles.....11

 1994 to 1998 Vehicles (12 valve).....11

DFIV INSTALLATION (1998-2002 24V Vehicles)13

CRUISE CONTROL WIRING 2000-2002 6-speed HO (IF EQUIPPED).....14

Optional Shifter Switch (Push-Pull Style)15

Optional Shifter Switch (Rocker Switch Style).....16

HOSE & WIRING DIAGRAM (1988-1998 12 Valve)17

HOSE & WIRING DIAGRAM (1998-2002 24 Valve)18

DFIV Adjustment & Testing (1998-2002 24 Valve Only)19

BRAKE TESTING19

MAINTENANCE & TROUBLESHOOTING.....20

SPOOL VALVE MAINTENANCE21

 Disassembly21

 Cleaning21

 Re-Assembly21

 Testing.....22

HELPFUL HINTS22

OPERATING GUIDELINES.....22

Vacuum Brake Troubleshooting Guide.....25

Questions?.....25

Welcome

Thank you for purchasing a BD Exhaust Brake. This manual is divided into different areas to assist you with your installation and operation of your braking unit. We strongly suggest that you write down the kit and serial numbers of your unit in the spaces provided and retain this manual for any future reference.

Kit Contents

2033135 - 1988-1998 Dodge Cummins 12V Exhaust Brake Kit

1	1230030	Vacuum Control Kit (w/ Micro Switch)
1	1230335	Vacuum Spool Valve Kit
1	2133030	Exhaust Brake

2033137 - 1998-2002 Dodge Cummins 24V Exhaust Brake Kit

1	1321039	DFIV (Idle Verifier) Application Kit
1	1230335	Vacuum Spool Valve Kit
1	2133030	Exhaust Brake
1	1130805	Dodge Brake Adapter Casting
1	1409591	Dodge Brake Adapter Clamp
1	1409592	Turbo Adapter Gasket

BD Engine Brake Inc.

Plant Address: 33541 MacLure Rd. Abbotsford, BC, Canada V2S 7W2

U.S. Shipping Address: 88-446 Harrison St, Sumas, WA 98295 U.S. Mailing Address: P.O. Box 231, Sumas, WA 98295

Phone: 604-853-6096 | Fax: 604-853-8749 | Internet: www.bd-power.com

Pre-Installation

Before installation can begin, we must take a look at any other requirements or options for your particular application.

1993 and older Dodge trucks: A new BD Turbo Down Pipe (**Part # 1040050**) will be necessary for the brake install, due to the different position of the exhaust outlet with the brake installed on the turbo.

1988-1998 6BTA Dodges trucks: Heavy-duty exhaust valve springs (Kit Part # 1030060) must be installed before operation of BD Exhaust Brake. Most trucks in these years come standard with 40# springs and they will not hold the back pressure created by this 60# exhaust brake system!

Serious engine damage could result if they are not installed!

This kit comes with a toggle switch for master power, but, as a desired option for manual transmissions, you may want to order a gear shifter switch kit. This kit is similar to the two-speed rear axle buttons used on highway tractors and aftermarket auxiliary transmissions, and makes for handy operation of the brake when in conditions of constant gear shifting. They are available in both a push/pull style and a “rocker” switch style. More information can be found later on in this installation manual.

Unlike the manual transmission, 88-93 automatic transmissions do not have a direct coupling between the transmission and engine. Therefore, efficient retarding cannot be obtained unless the engine is kept at a high R.P.M. by gearing down. There are two ways that either one of them, or both, will achieve easier operation and greater retarding performance out of the exhaust brake when used on an automatic transmission:

- 1) In 88-93 vehicles better fluid coupling can be obtained with the installation of a **BD Torque Converter** (1060210x), which will not only improve retarding performance at lower RPM's, but, will also transfer more torque to the rear tires, giving more pulling power and performance.
- 2) On **1994-2002 Vehicles**, BD has Torque Converter Lock-Up kits available to keep the lock-up clutch in the converter engaged to give direct coupling, just like a manual transmission. This will also reduce transmission temperature with exhaust brake use. See Autoloc and Torqloc in the accessories section below.

BD Engine Brake Inc.

Plant Address: 33541 MacLure Rd. Abbotsford, BC, Canada V2S 7W2

U.S. Shipping Address: 88-446 Harrison St, Sumas, WA 98295 U.S. Mailing Address: P.O. Box 231, Sumas, WA 98295

Phone: 604-853-6096 | Fax: 604-853-8749 | Internet: www.bd-power.com

Special Tools Required

• Measuring tape or ruler	• Crimping Pliers
• Drill with 1/8", 3/16" bits and Unibit	• Small bladed flat tip screwdriver
• Test light	• Welder

Accessories

Description	Part #
Manual Transmission Shifter Switch Kit	1300210 / 1030900
AutoLoc Converter Lock-up Kit	1030390
Torqloc Converter Lock-up Kit	1030395
Brake Pressure Gauge Kit	1030050
HD Exhaust Valve Springs	1030060
88-93 Downpipe	1040050
88-93 HD Torque Converter	1060210x

Notes On Connectors

The kit includes a number of Posi-Tap™ connectors (Gray or Red/Black/Green or Yellow) to tap onto OEM wiring. It is important to select the correct color of connector so that it matches the gauge of the OEM wire that it is being installed on. Using the incorrect connector could cause an inadequate connection and/or the OEM wire could be severed.

OEM Wire	Posi-Tap™ Color
18-22ga	Red
12-18ga	Black
10-12ga	Yellow

Though these connectors offer a quicker installation, the best option would be to solder the wires and isolate the joints with heat shrink or liquid electrical tape. Proper soldering techniques should be used to ensure adequate connections.

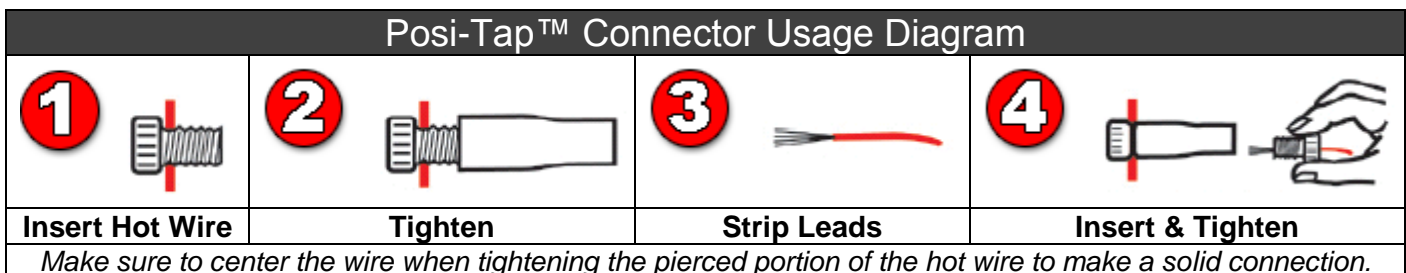

The ground terminals of the vehicle's batteries should be disconnected before performing any piercing/posi-tapping onto any ECM/PCM wire.

BD Engine Brake Inc.

Plant Address: 33541 MacLure Rd. Abbotsford, BC, Canada V2S 7W2

U.S. Shipping Address: 88-446 Harrison St, Sumas, WA 98295 U.S. Mailing Address: P.O. Box 231, Sumas, WA 98295

Phone: 604-853-6096 | Fax: 604-853-8749 | Internet: www.bd-power.com

Stock Turbo Configuration Diagram

Stock Turbo Configurations

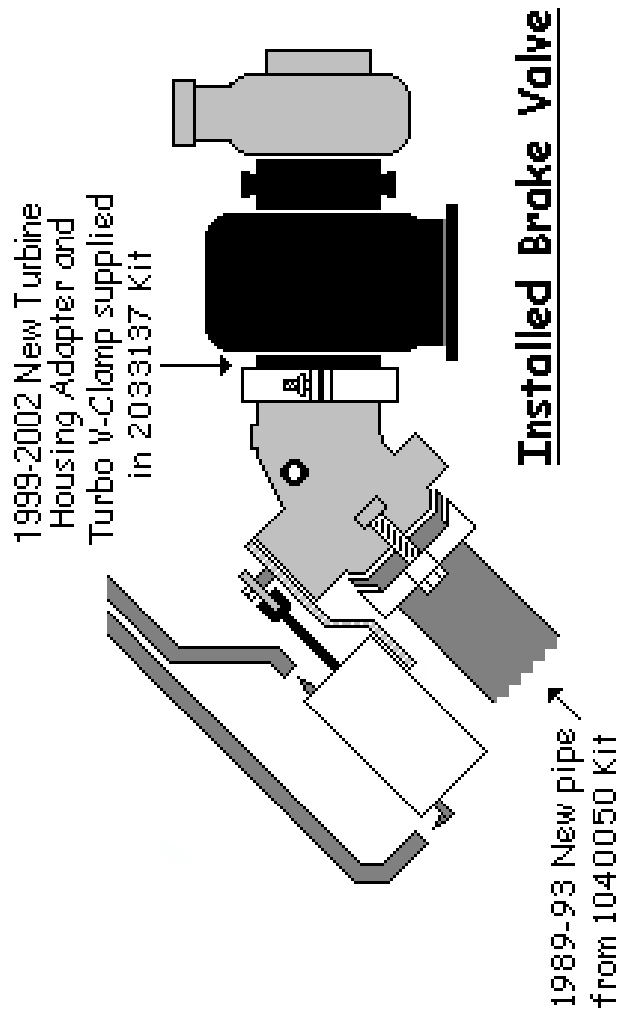
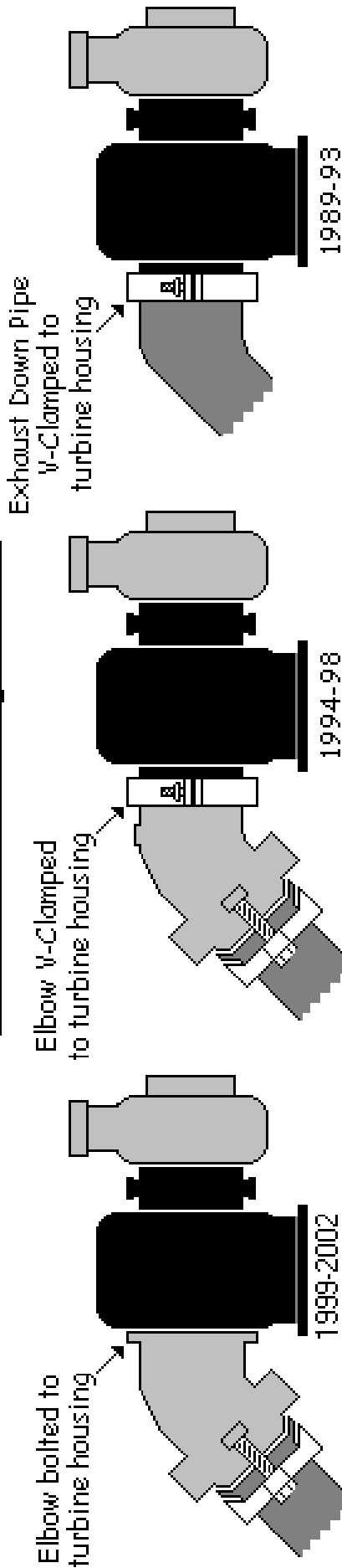

BD Engine Brake Inc.

Plant Address: 33541 MacLure Rd. Abbotsford, BC, Canada V2S 7W2

U.S. Shipping Address: 88-446 Harrison St, Sumas, WA 98295 U.S. Mailing Address: P.O. Box 231, Sumas, WA 98295

Phone: 604-853-6096 | Fax: 604-853-8749 | Internet: www.bd-power.com

BRAKE VALVE INSTALLATION

1988 to 1993 Dodge Cummins

From underneath the vehicle, remove the first hanger clamp and U-clamp on the down pipe coming from the turbo. Cut the pipe where the U-clamp was previously. Remove and retain the turbo exhaust clamp securing the exhaust down pipe to the turbo; inspect clamp to make sure the inner surfaces are not damaged. Remove old down pipe and clean any excess carbon build up on exhaust mating surfaces, checking for anything may cause problems with sealing.

Install Brake Valve Assembly on the turbo using original turbo exhaust clamp, while keeping enough clearance between Vacuum Cylinder, automatic transmission dipstick tube and engine exhaust manifold. Install new down pipe (Part # 1040050) with the flared end and mounting flange bolting up to the turbo, and the expanded end sliding over the existing intermediate pipe. Seal the joint of the two pipes with the supplied band clamp, and, reinstall old hanger clamp.

1994 to 1998 Vehicles

Remove cast exhaust elbow from turbo by removing turbo exhaust clamp and exhaust pipe flange bolts. Inspect turbo exhaust clamp, turbo down pipe and turbo outlet for any carbon build up or damage that may cause problems sealing on exhaust mating surfaces.

Install Brake Valve Assembly on the turbo using original turbo exhaust clamp, keep enough clearance between Vacuum Cylinder, automatic transmission dipstick tube, and engine exhaust manifold. Use the original turbo down pipe flange bolts to secure the pipe to Brake Valve Assembly. (NOTE: Some modification of the dipstick tube may be necessary.)

1998½ to 2002 Vehicles

Unbolt exhaust down pipe from turbo exhaust elbow. Unbolt and remove turbo exhaust elbow from turbo. Using the same bolts, install supplied adapter plate onto turbo. Torque bolts to 110 inch lb., then re-torque to 220-inch lb.

Install the brake valve assembly onto the turbo using the supplied turbo exhaust clamp. Keep enough clearance between the vacuum cylinder, automatic transmission dipstick tube and the engine exhaust manifold.

Secure the pipe to the exhaust brake using the original turbo down-pipe flange bolts. (NOTE: Some modification of the dipstick tube may be necessary)

BD Engine Brake Inc.

Plant Address: 33541 MacLure Rd. Abbotsford, BC, Canada V2S 7W2

U.S. Shipping Address: 88-446 Harrison St, Sumas, WA 98295 U.S. Mailing Address: P.O. Box 231, Sumas, WA 98295

Phone: 604-853-6096 | Fax: 604-853-8749 | Internet: www.bd-power.com

SPOOL VALVE INSTALLATION

The Spool Valve has two hoses of unequal length attached to it. Push the longer hose onto the barb fitting on the back of the Vacuum Cylinder, and the shorter line onto the barb fitting on the front **Blue** cap. Maneuver the Spool Valve over to the driver's side of the engine, keeping the hoses out of the way of any moving or heated items on the engine.

1988 to 1993 Vehicles

Mount the Spool Valve onto the topside on the Extension Bracket (included in kit # 1040050) with the Spool Valve wire w/stud (eye-hole) connector under the bolt, and, mount the bracket onto the Air Inlet Horn on the firewall side.

1994 to 2002 Vehicles

Mount the Spool Valve onto one of bolts of the air inlet on the driver's side of the engine with the Spool Valve wire w/stud (eye-hole) connector under the bolt.

Caution!! Be sure to route all hoses and wiring away from any heat sources (i.e. exhaust manifolds) or any moving parts.

VACUUM SUPPLY

1988 to 1996 vehicles with vacuum power brakes

Locate the factory vacuum hose running from the vacuum pump to the vacuum brake booster. Cut this hose approximately 2 inches before (on the vacuum pump side of) the vacuum check valve. Install the supplied plastic tee into the factory hose and route the supplied vacuum hose from the tee over to the spool valve. Trim the hose to length and push it onto the barbed fitting on the #1 port of the spool valve. (The port numbers are stamped into the spool valve adjacent the ports). Ensure the hose does not come too close to any moving parts or major heat sources.

BD Engine Brake Inc.

Plant Address: 33541 MacLure Rd. Abbotsford, BC, Canada V2S 7W2

U.S. Shipping Address: 88-446 Harrison St, Sumas, WA 98295 U.S. Mailing Address: P.O. Box 231, Sumas, WA 98295

Phone: 604-853-6096 | Fax: 604-853-8749 | Internet: www.bd-power.com

1997 to 2002 Vehicles

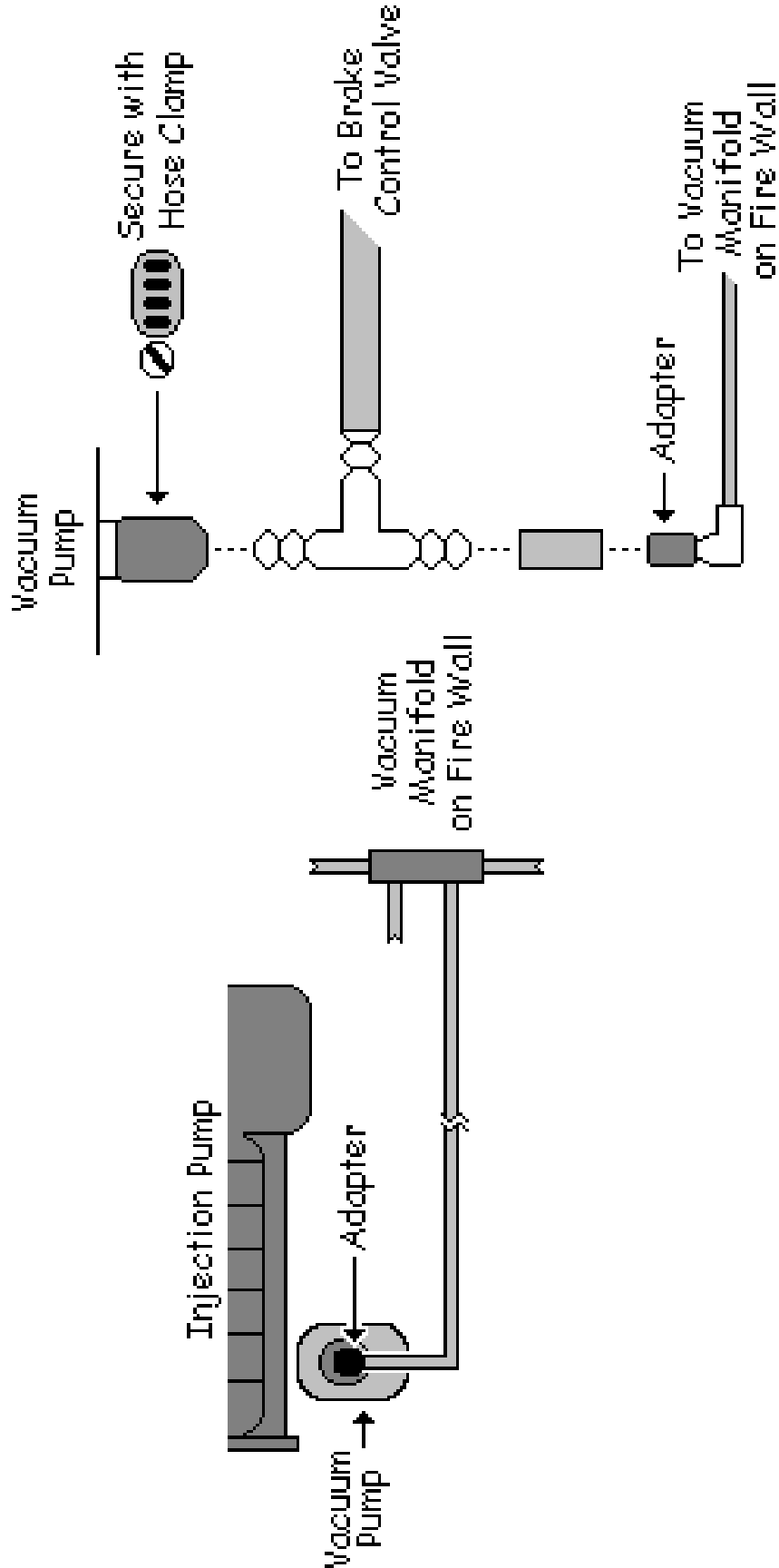

BD Engine Brake Inc.

Plant Address: 33541 MacLure Rd. Abbotsford, BC, Canada V2S 7W2

U.S. Shipping Address: 88-446 Harrison St, Sumas, WA 98295 U.S. Mailing Address: P.O. Box 231, Sumas, WA 98295

Phone: 604-853-6096 | Fax: 604-853-8749 | Internet: www.bd-power.com

1997 to 2002 vehicles with hydroboost power brakes

Locate the factory vacuum pump (it has the power steering pump bolted to the back of it), just below the injection pump. You will see that there is an adapter hose on the vacuum pump outlet which steps down to a small o/d hose which runs to a vacuum manifold on the firewall. Disconnect the adapter from the vacuum pump and install the supplied plastic tee onto the pump outlet. The short piece of supplied hose goes on the vacuum pump outlet and the factory adapter hose goes on the other end of the tee. Route the supplied vacuum hose from the tee up to the spool valve, trim it to length and install it onto the barbed fitting on the #1 port of the spool valve. (The port numbers are stamped into the spool valve adjacent the ports). Ensure the hose does not come too close to any moving parts or major heat sources.

BD Engine Brake Inc.

Plant Address: 33541 MacLure Rd. Abbotsford, BC, Canada V2S 7W2

U.S. Shipping Address: 88-446 Harrison St, Sumas, WA 98295 U.S. Mailing Address: P.O. Box 231, Sumas, WA 98295

Phone: 604-853-6096 | Fax: 604-853-8749 | Internet: www.bd-power.com

THROTTLE SWITCH INSTALLATION (1988-1998 Vehicles)

1988 to 1993 vehicles

Mount the supplied throttle micro switch to the supplied throttle switch bracket. On the timing cover on the front of the engine, remove the top 2 timing cover bolts (10mm) on the drivers side and the throttle return spring bracket (if present). Mount the supplied throttle switch bracket in this spot, using the original timing cover bolts and reinstall the throttle return spring (if present) in the hole provided. See diagram below.

Line up the small silver button on the micro switch with the throttle linkage so that the button is depressed when the throttle is at idle. This will close the circuit in the micro switch to activate the exhaust brake (you can hear the switch click when the button is pressed or released). The button should release when the throttle is brought off idle.

NOTE: If the throttle return springs are weak, they may not be strong enough to depress the button on the micro switch. In this case the springs will have to be replaced or additional springs added. Also, worn throttle linkage can make it difficult to get the micro switch to activate consistently.

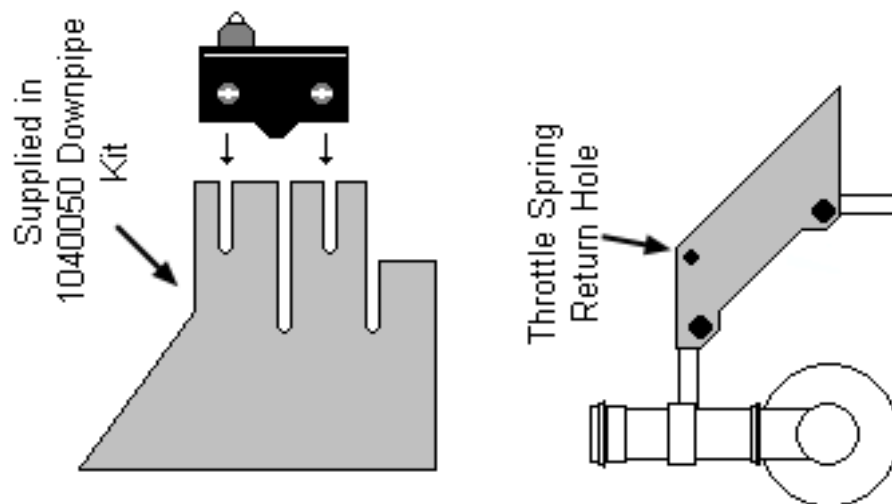

Connect a length of the supplied wire from the “com” terminal on the micro switch to the red wire on the spool valve. Run another length of wire from the “NO” (Normally Open) terminal through the firewall. This will be connected later.

1994 to 1998 Vehicles (12 valve)

At the throttle pedal, locate the nuts on the large aluminum bracket just up from and to the left of the pedal. These nuts support the aluminum bracket on the firewall and are the mounting for the throttle and brake pedal. Remove the lower nut and loosen off the top nut. In the kit you will find the long Micro Switch Bracket, which has two long slots for the Micro Switch.

BD Engine Brake Inc.

Plant Address: 33541 MacLure Rd. Abbotsford, BC, Canada V2S 7W2

U.S. Shipping Address: 88-446 Harrison St, Sumas, WA 98295 U.S. Mailing Address: P.O. Box 231, Sumas, WA 98295

Phone: 604-853-6096 | Fax: 604-853-8749 | Internet: www.bd-power.com

Slide the top end of the bracket (w/cut out slot) under the loosened upper nut and lay it against the aluminum bracket so the stud that was exposed when you removed the lower nut protrudes through the other slot on the Throttle Switch Bracket. Screw the lower nut back onto stud, but do not tighten nuts yet.

In the kit, find the small 2 3/8" long bracket with two holes. The arm of the throttle pedal starts off wide, then angles off into a thinner section further up the pedal. Just before the pedal's arm angles to the thinner section, place the middle hole of the bracket on the still wide section, close to the edge and angle this bracket towards the Micro Switch on the other bracket you installed above.

Ensure sufficient clearance between the long Micro Switch Bracket and the throttle pedal by sliding the bracket as far to the left as possible, to eliminate any possibility of pedal catching on bracket. Adjust both brackets so that the small bracket on the pedal arm will depress the button on the Micro Switch when the pedal is in the idle position.

When satisfied, mark and drill the two holes on the pedal arm and screw or pop rivet pedal bracket to arm. Tighten the nuts for the aluminum bracket and do final adjustments to Micro Switch bracket on the aluminum bracket.

Make sure the screws supporting the Micro Switch and screws for the electrical wires on Switch are tight. Periodic adjustment to the Throttle Switch might be needed to maintain proper contact with bracket on throttle pedal.

NOTE: If the throttle return springs are weak, they may not be strong enough to depress the button on the micro switch. In this case the springs will have to be replaced or additional springs added. Also, worn throttle linkage can make it difficult to get the micro switch to activate consistently.

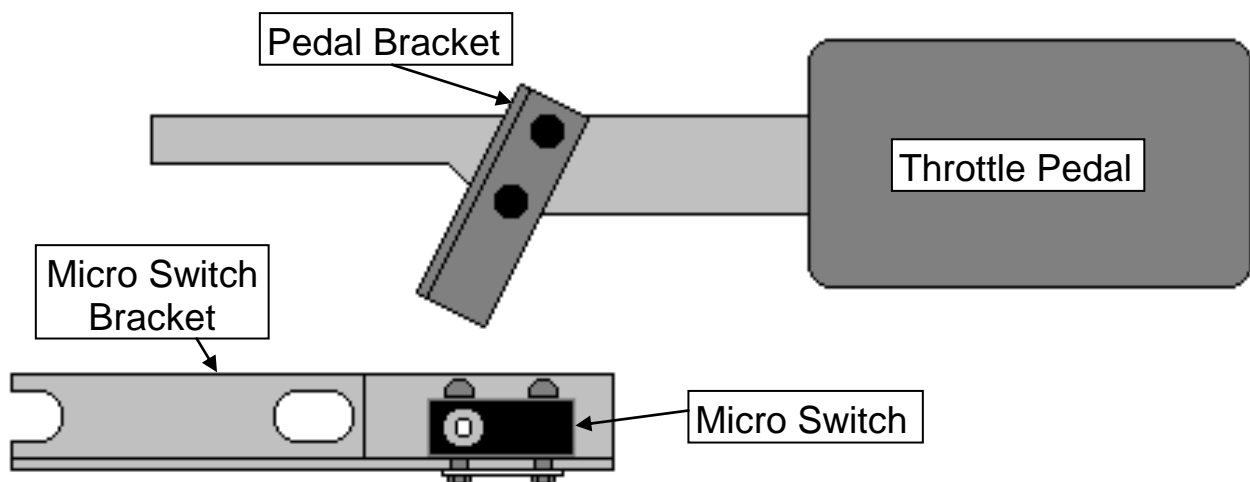

Connect a length of the supplied wire from the "com" terminal on the micro switch to the red wire on the spool valve. Run another length of wire from the "NO" (Normally Open) terminal through the firewall. This will be connected later.

BD Engine Brake Inc.

Plant Address: 33541 MacLure Rd. Abbotsford, BC, Canada V2S 7W2

U.S. Shipping Address: 88-446 Harrison St, Sumas, WA 98295 U.S. Mailing Address: P.O. Box 231, Sumas, WA 98295

Phone: 604-853-6096 | Fax: 604-853-8749 | Internet: www.bd-power.com

DFIV INSTALLATION (1998-2002 24V Vehicles)

Mount the DFIV module in a secure location under the dash using the cable ties provided. Route the pink and yellow wires through the firewall into the engine bay, there is usually an existing grommet in the firewall behind the brake pedal which can be used for this. Attach the black ground wire to the "Gnd" terminal on the DFIV and attach the ring terminal to a good ground.

Route the Yellow wire from the DFIV module along the driver side of the engine to the throttle linkage and APPS Sensor.

Remove the cover of the throttle linkage then locate and disconnect the wiring connector for the APPS.

NOTE: This connector is located on the underside of the throttle linkage assembly and is in a difficult position.

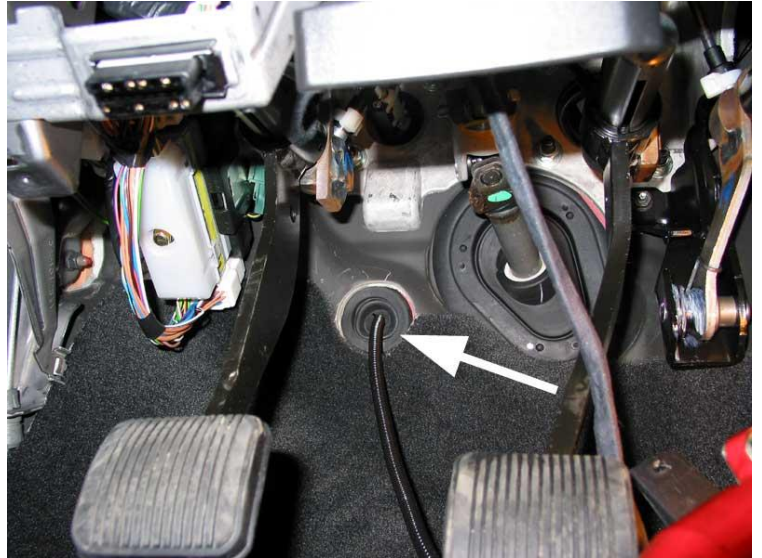

Open the loom and locate the Light Blue w/Black wire and install a supplied Posi-Tap™ to it.

Connect the Yellow wire from the DFIV Module to this Posi-Tap™ and reconnect the APPS connector then reinstall the throttle linkage cover.

Throttle linkage cover removed

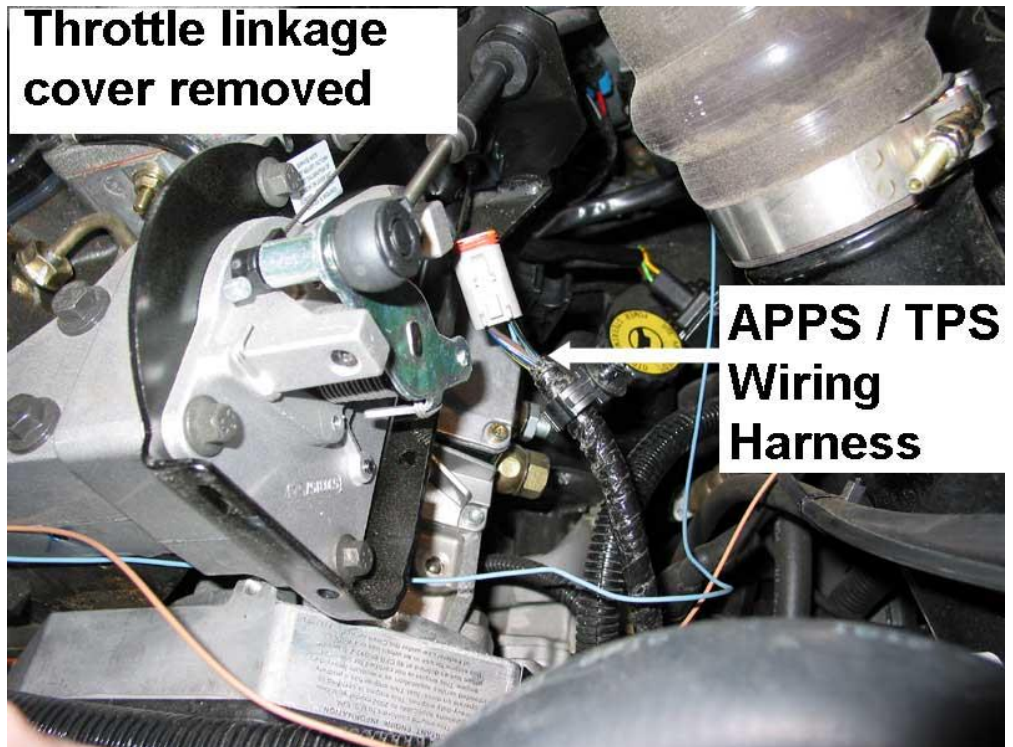

**APPS / TPS
Wiring
Harness**

BD Engine Brake Inc.

Plant Address: 33541 MacLure Rd. Abbotsford, BC, Canada V2S 7W2

U.S. Shipping Address: 88-446 Harrison St, Sumas, WA 98295 U.S. Mailing Address: P.O. Box 231, Sumas, WA 98295

Phone: 604-853-6096 | Fax: 604-853-8749 | Internet: www.bd-power.com

CRUISE CONTROL WIRING 2000-2002 6-speed HO (IF EQUIPPED)

If your vehicle does not have cruise control you can remove the blue and green wires from the DFIV and discard them. Skip this step and proceed to Switch Installation.

To obtain access to the Cruise Control wiring harness remove the lower steering column panel by removing the mounting screws and unsnapping the panel from the instrument panel.

Under the dash running vertical by the left of the steering column, locate the smaller wiring harness that runs out of the main harness.

Remove some of the black electrical tape to gain access to the smaller wire bundle.

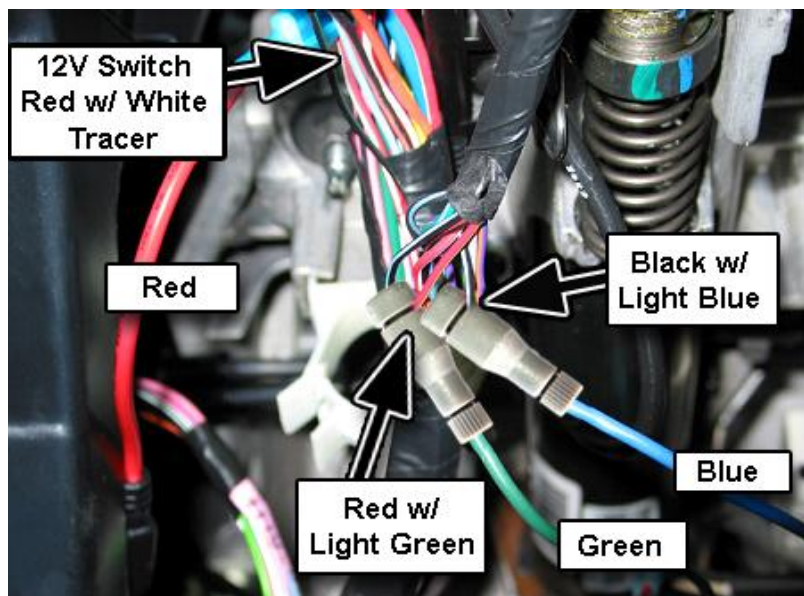

*****DANGER*****

THERE IS A BLACK WIRE WITH A TWISTED LIGHT BLUE/GREEN TRACER DO NOT CONNECT OR TEST THIS WIRE AS IT IS CONNECTED TO THE AIR BAG AND THE BAG MAY DEPLOY CAUSING DAMAGE AND/OR INJURY

*****DANGER*****

Remove some of the black electrical tape from the small bundle to gain access to the small Black wire with Light Blue tracer and install a Posi-Tap™ to it. Insert the Blue wire from the DFIV module into this connector.

In this same wiring harness, locate the Red wire with Light Green tracer and install another Posi-Tap™. Insert the Green wire from the DFIV module into this connector.

BD Engine Brake Inc.

Plant Address: 33541 MacLure Rd. Abbotsford, BC, Canada V2S 7W2

U.S. Shipping Address: 88-446 Harrison St, Sumas, WA 98295 U.S. Mailing Address: P.O. Box 231, Sumas, WA 98295

Phone: 604-853-6096 | Fax: 604-853-8749 | Internet: www.bd-power.com

TOGGLE SWITCH INSTALLATION

If you wish to use an optional shifter-mounted switch for manual transmissions you can skip installing the toggle switch and proceed to the shifter switch installation.

Choose a spot in the dash to mount the toggle switch, ensuring that there is room in behind for the switch body. Drill a 1/8" pilot hole and then open it up to 1/2" using a unibit. Be careful not to drill into any wires or other components. Mount the switch in the hole using the switch lock ring.

Locate one of the switched ignition power wires under the steering column. These are red w/black tracer, one is 10/12 gauge and another is 14/16 gauge. Install a Posi-Tap onto one of these wires and connect the fused red wire provided with the toggle switch to this point. Attach the other red wire to one of the terminals on the micro switch (12 valve) or to the "Switch" terminal on the DFIV (24 valve). Attach the black ground wire on the toggle switch to ground (you can also attach it to the "Gnd" terminal on the DFIV on 24 valves).

Optional Shifter Switch (Push-Pull Style)

Mount the shifter switch onto the shift lever using the clamp supplied (either 5/8" or 3/4"). Run the electrical cable down the shifter shaft, securing the cable with zip-ties or electrical tape, and run it under the carpet to the firewall and under the dash to the Micro Switch/DFIV, leaving enough slack for proper shifting of the transmission lever and to prevent any rubbing of wire.

At the end of the cable, cut off any excess and strip away about 1 to 2 inches of the black rubber covering exposing the black and white (or green) wires then strip the insulation from the ends of the two wires.



Connect the white (or green) wire to the "NO" (Normally Open) terminal of the micro switch (12 valve) or to the "Switch" terminal on the DFIV Module (24Valve).

Locate one of the ignition switched red/black tracer wires under the steering column (one is 10/12ga and the other is 14/16ga) and connect an appropriate Posi-Tap connector to it (green for 10/12ga and black for the 14/16ga wire) then connect the black wire to this Posi-Tap.

BD Engine Brake Inc.

Plant Address: 33541 MacLure Rd. Abbotsford, BC, Canada V2S 7W2

U.S. Shipping Address: 88-446 Harrison St, Sumas, WA 98295 U.S. Mailing Address: P.O. Box 231, Sumas, WA 98295

Phone: 604-853-6096 | Fax: 604-853-8749 | Internet: www.bd-power.com

Optional Shifter Switch (Rocker Switch Style)

Mount the shifter switch onto the shift lever using the clamp supplied (either 5/8" or 3/4"). Run the electrical cable down the shifter shaft, securing the cable with zip-ties or electrical tape, and run it under the carpet to the firewall and under the dash to the Micro Switch /DFIV, leaving enough slack for proper shifting of the transmission lever and to prevent any rubbing of wire.

At the end of the cable, cut off any excess and strip away about 1-2" of the black rubber insulation exposing the black, white and green wires, then strip the insulation from the ends of the three wires.

Connect the white (or green) wire to the "NO" (Normally Open) terminal of the micro switch (12 valve) or to the "Switch" terminal on the DFIV Module (24 Valve).

Attach the 5/16" ring connector to the black ground wire and attach it to a good ground nearby, or to the ground terminal of the DFIV (24 valve)

Locate one of the ignition switched red/black tracer wires under the steering column (one is 10/12ga and the other is 14/16ga) and connect an appropriate Posi-Tap connector to it (green for 10/12ga and black for the 14/16ga wire) then connect the black wire to this Posi-Tap.

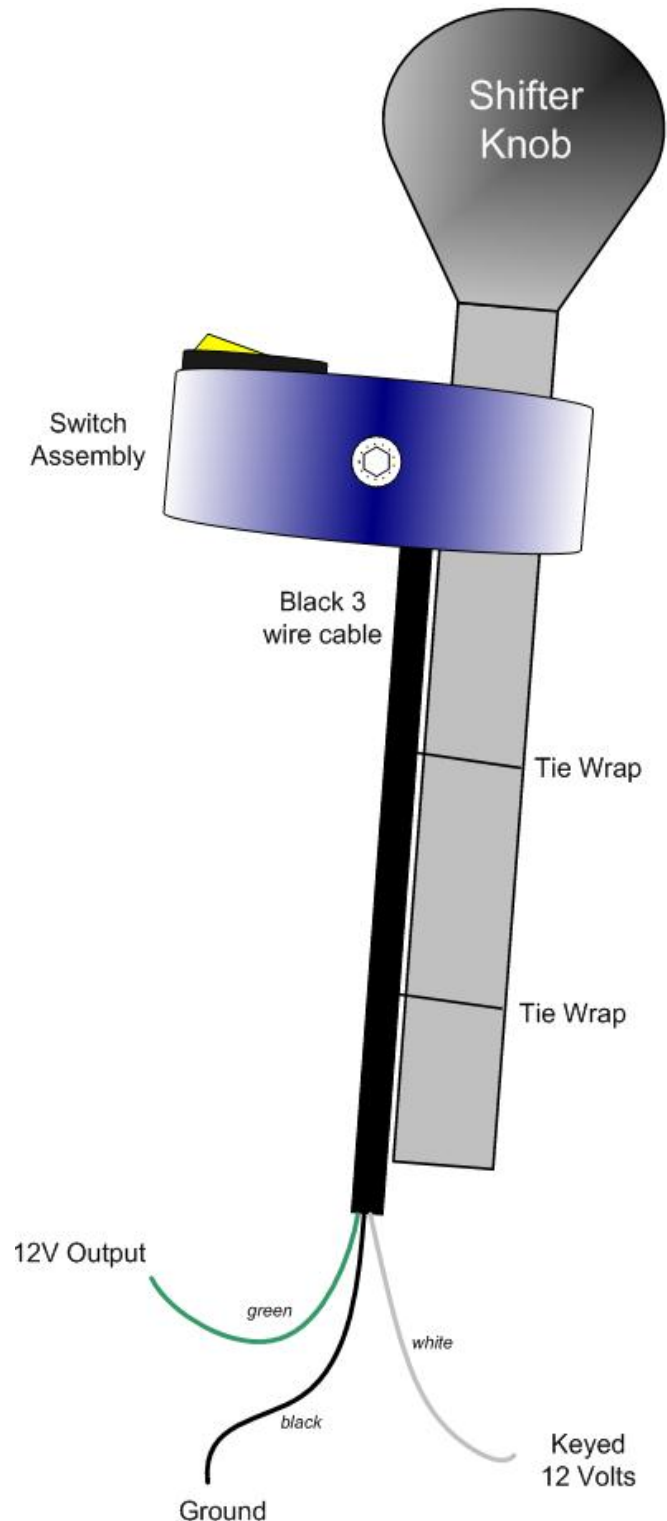

BD Engine Brake Inc.

Plant Address: 33541 MacLure Rd. Abbotsford, BC, Canada V2S 7W2

U.S. Shipping Address: 88-446 Harrison St, Sumas, WA 98295 U.S. Mailing Address: P.O. Box 231, Sumas, WA 98295

Phone: 604-853-6096 | Fax: 604-853-8749 | Internet: www.bd-power.com

HOSE & WIRING DIAGRAM (1988-1998 12 Valve)

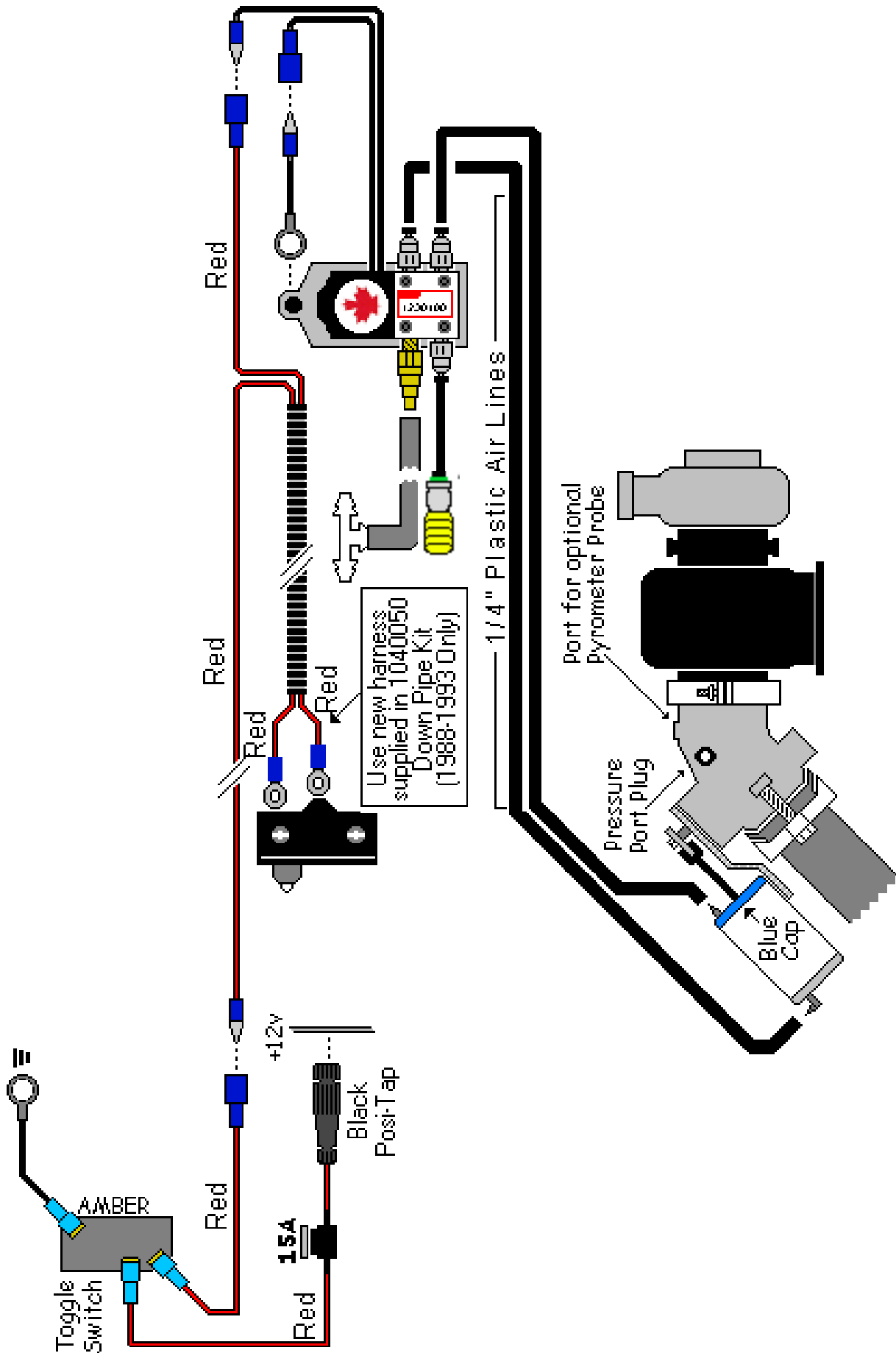

HOSE & WIRING DIAGRAM (1998-2002 24 Valve)

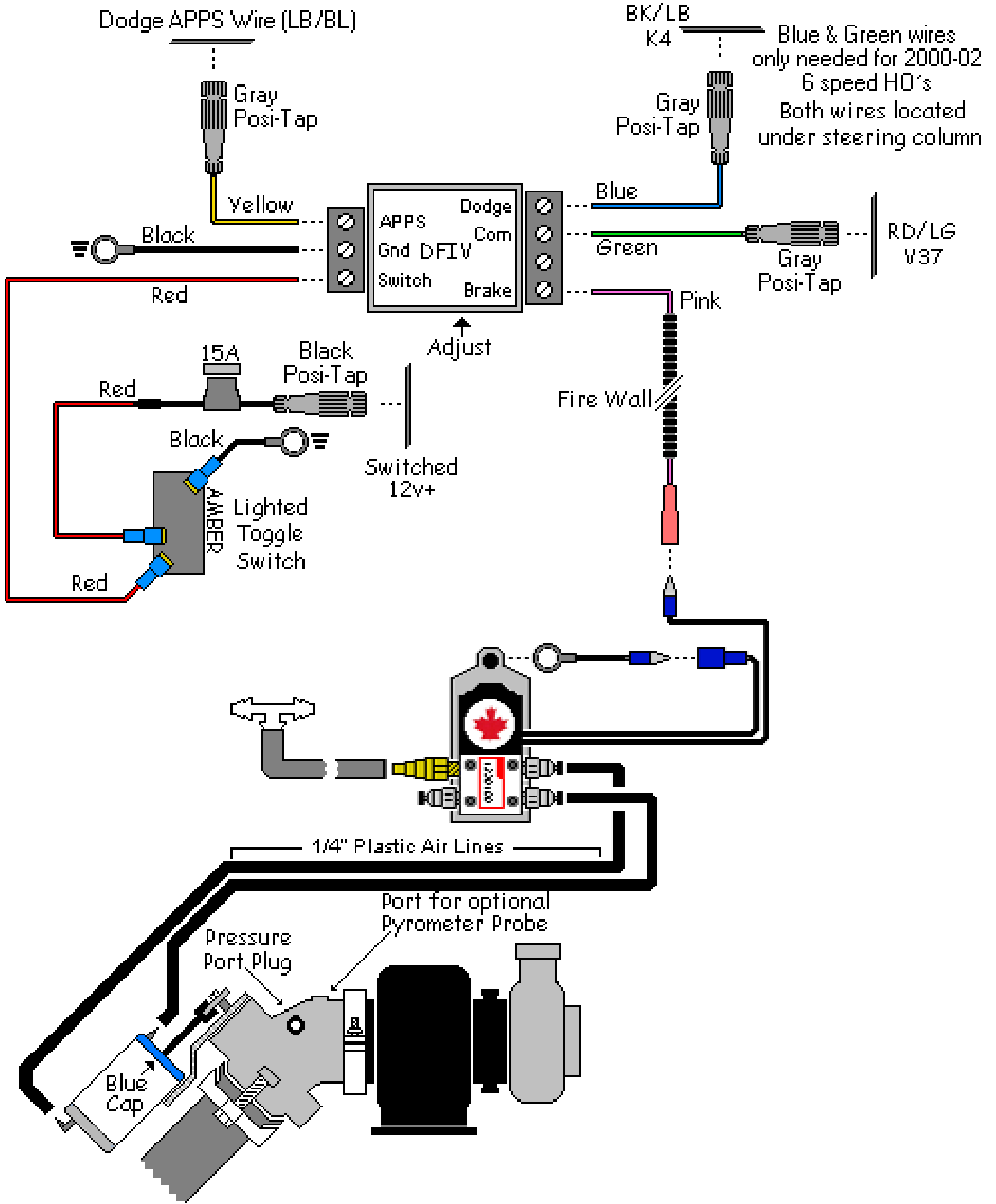

BD Engine Brake Inc.

Plant Address: 33541 MacLure Rd. Abbotsford, BC, Canada V2S 7W2

U.S. Shipping Address: 88-446 Harrison St, Sumas, WA 98295 U.S. Mailing Address: P.O. Box 231, Sumas, WA 98295

Phone: 604-853-6096 | Fax: 604-853-8749 | Internet: www.bd-power.com

DFIV Adjustment & Testing (1998-2002 24 Valve Only)

Ensure the connections of the corresponding wires to the DFIV Control Module are correct as shown in the wiring diagram.

To achieve the correct setting for the activation of the exhaust brake in relation to the throttle pedal the DFIV Module must be calibrated for your vehicle.

With the throttle at idle, start the engine and turn on brake switch. Then, using a small flat bladed screwdriver, turn the small adjusting screw in the DFIV Module counterclockwise or clockwise until the brake JUST turns on.



CAUTION: THE ADJUSTING SCREW IS A MICRO-SWITCH WHICH IS VERY DELICATE, SO TURN USING SMALL ADJUSTMENTS.

Test by revving up the engine to approximately 1200 RPM and releasing the throttle. As the accelerator pedal is applied the brake should disengage just before then engine starts to rev, indicating proper calibration of the DFIV Module with the APPS.

Then the brake should activate again when the throttle pedal returned to idle. If not, readjust the DFIV Module so that it does.

Check for any exhaust leaks and recheck all connections and hoses for security and interference from moving or heated items. After about 100 miles (160 km), re-torque the flange bolts.

BRAKE TESTING

Start the engine and turn on the toggle or shifter switch. With the throttle at idle, the brake should come on. Rev the engine and check that the brake disengages when the throttle pedal is brought off idle and re-engages when it returns to idle. If it does not, adjust the position of the Micro Switch (12-valve) or adjust the DFIV module as described on the previous page.

On 1988-93, if the pedal can be manually pulled up to activate the switch, then add a return spring (or second spring if it already has one) to the throttle assembly.

Check for any exhaust leaks and recheck all connections and hoses for security and interference from moving or heated items. After about 100 miles (160 km), re-torque the turbo exhaust clamp and flange bolts.

BD Engine Brake Inc.

Plant Address: 33541 MacLure Rd. Abbotsford, BC, Canada V2S 7W2

U.S. Shipping Address: 88-446 Harrison St, Sumas, WA 98295 U.S. Mailing Address: P.O. Box 231, Sumas, WA 98295

Phone: 604-853-6096 | Fax: 604-853-8749 | Internet: www.bd-power.com

The brake may need to be adjusted for the vehicle. If more holdback performance is required with the vehicle loaded, adjust the rod on the Vacuum Cylinder to close off the valve tighter.

NOTE: Only slight adjustments are required to gain desired effect, and, all adjustments should be done with vehicle turned off.

It is required that a standard pressure gauge be used to make the necessary adjustments to the brake valve. Adjust the brake to reach approximately 20-25 lb. on 24 Valve ISB motors and on 12 Valve 6BTA motors that have had the exhaust valves spring changed. For 12 Valve 6BTA motors that still have the stock exhaust valve springs, adjust the brake to 10-15 lb. when the engine is at idle.

NOTE: Over the two weeks, the back pressure at idle may rise due to initial carbon build-up, the brake valve will need to be adjusted again.

MAINTENANCE & TROUBLESHOOTING

To extend life of Valve Assembly, do not operate vehicle for extended periods of time without activating the Brake. We suggest activating the Brake at least a couple times on any day you operate the vehicle, to prevent any carbon or rust build up on inner parts of the Valve Assembly.

The hoses, wires, fittings and clamps should be inspected on a regular basis for any deterioration, damage or leaks. The position of the Micro Switch may have to be adjusted, depending on condition of throttle linkages and return springs.

Periodically clean the filter on the Spool Valve, and, when cleaning the engine, cover the Spool Valve to prevent moisture from entering filter. Following the diagrams in this manual, tracing hoses and wiring, checking continuity through electric components or checking for any lines that are disconnected, should solve any problems that may arise.

To increase the life of your exhaust brake we recommend daily operation. This could simply be switching it on and off a couple times a day and will prevent the butterfly from sticking due to carboning up.

BD Engine Brake Inc.

Plant Address: 33541 MacLure Rd. Abbotsford, BC, Canada V2S 7W2

U.S. Shipping Address: 88-446 Harrison St, Sumas, WA 98295 U.S. Mailing Address: P.O. Box 231, Sumas, WA 98295

Phone: 604-853-6096 | Fax: 604-853-8749 | Internet: www.bd-power.com

SPOOL VALVE MAINTENANCE

Disassembly

- Remove the two coil screws.
- Remove the two rear plate screws.
- Pop out the white and black bumpers, springs, and O-rings.
- Remove the spool and sleeve assembly from the valve body with a plastic or wooden rod approximately the same size as the outside diameter of the sleeve.

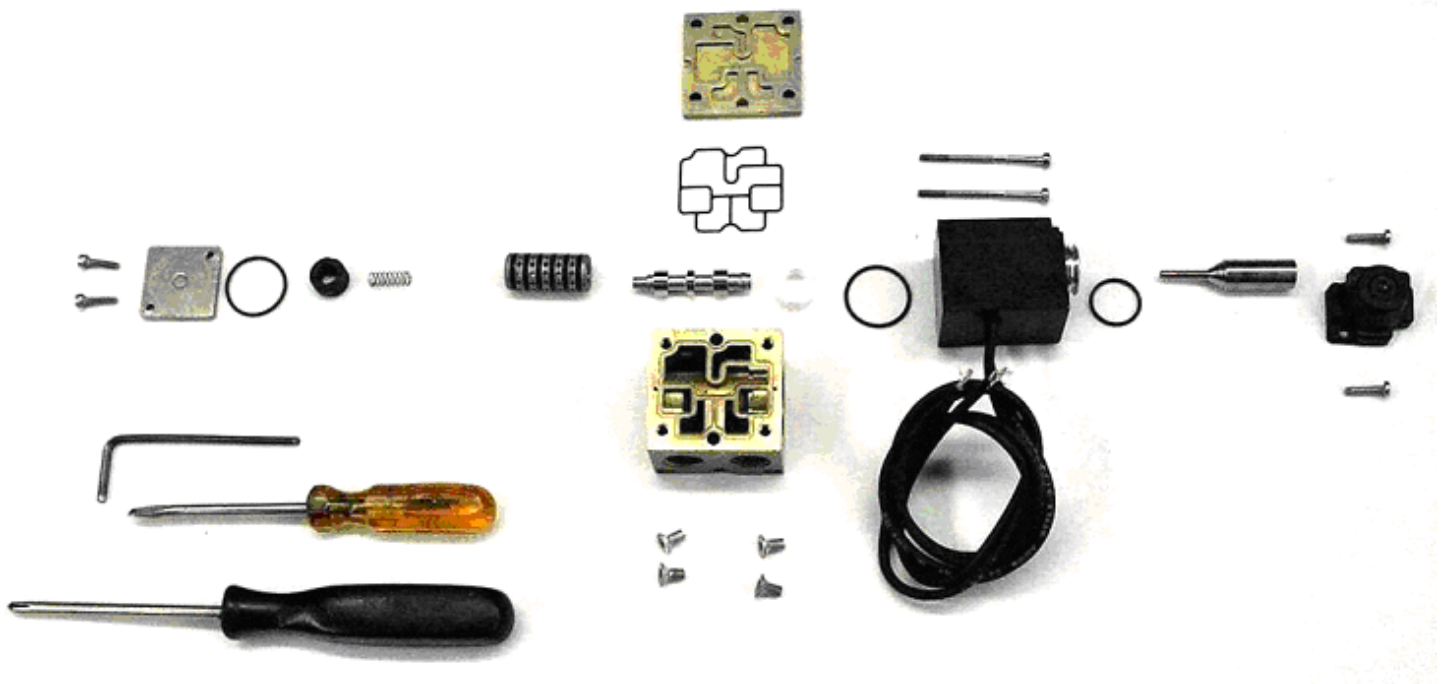

Cleaning

- Clean the spool and sleeve with some WD40 and compressed air.
- Inspect the spool and sleeve for any damage and inspect O-rings.
- The spool should move freely within the sleeve.

Re-Assembly

- Re-install the rear plate, O-ring, and black bumper onto the body.
- Gently slide the sleeve into the body cavity by pushing and turning at the same time.

BD Engine Brake Inc.

Plant Address: 33541 MacLure Rd. Abbotsford, BC, Canada V2S 7W2

U.S. Shipping Address: 88-446 Harrison St, Sumas, WA 98295 U.S. Mailing Address: P.O. Box 231, Sumas, WA 98295

Phone: 604-853-6096 | Fax: 604-853-8749 | Internet: www.bd-power.com

- Drop the spring into the sleeve.
- Gently insert the spool into the sleeve with a slow, turning action. NOTE: The residual WD40 should be enough lubricant for assembly.
- Check to ensure that there is very little resistance felt when it's inserted. NOTE: If any resistance or binding is noted, remove the spool and try again.
- Once the spool is inserted and moving freely, reattach the coil, white bumper, and O-ring.

Testing

- After reassembly is completed, push and release the manual override button. The spool should move and return freely.
- If you have an air compressor, blow low-pressure (20-30 psi) air into Port #1, then push the override button. There should be a transfer of flow from Port #2 to Port #4.
- Re-install the valve on the engine, hook up the disconnected vacuum lines and wiring, then check for correct operation of Brake, PressureLoc, etc.

HELPFUL HINTS

Make sure all parts are spread out on a clean, lint-free surface while servicing valve.

****CAUTION**** Do NOT use heavy grease or oils on the spool, sleeve, or O-rings. (Oil based lubricants will swell and distort rubber O-rings).

Do not use any abrasive compounds on the spool or the sleeve.

Make sure all of the O-rings are re-installed and are in good condition by checking for nicks, scoring, or other damage.

OPERATING GUIDELINES

Thank you for taking interest in the BD Engine Exhaust Brake. As a driver, you probably already know the need for extra braking power that your vehicle requires on the hills and long grades. With loads being towed behind you, the extra push when slowing down or maintaining speed on downward grades can prove to be a strain on the vehicle's hydraulic braking system, even to the point of "burn-up".

These guidelines were designed to offer you a better understanding of the benefits of exhaust brakes and are partly based upon material developed by the U.S. Department of Transportation National Highway Traffic Safety Administration.

BD Engine Brake Inc.

Plant Address: 33541 MacLure Rd. Abbotsford, BC, Canada V2S 7W2

U.S. Shipping Address: 88-446 Harrison St, Sumas, WA 98295 U.S. Mailing Address: P.O. Box 231, Sumas, WA 98295

Phone: 604-853-6096 | Fax: 604-853-8749 | Internet: www.bd-power.com

The emphasis on today's vehicles is to give the consumer a product that can give them usable power with fuel efficiency. But, in the transition, the vehicles have lost their natural braking power, making it more easy for the vehicle to continue to roll and harder to stop. Of course, this gets more noticeable with the increase of weight, on or behind the vehicle. This is where an exhaust brake becomes a useful tool in increasing the driveline drag of the vehicle without the use of the hydraulic brakes and with maximum use or even occasional use, can reduce wear on hydraulic braking parts and at the same time increase safety.

The BD Exhaust Brake can be used to help maintain a controlled vehicle speed on a downward grade, as well as slowing the vehicle down for such times as turns or exit ramps, without you using your hydraulic brakes. **However, the exhaust brake cannot be used as a parking brake or will not bring your vehicle to a complete stop.**

By using a BD Exhaust Brake, the life and effectiveness of your hydraulic brakes will increase. This is because of the decreased use of the hydraulic brakes in situations like hills, the wear factor is reduced and there is less opportunity for your hydraulic brakes to heat up which would reduce the efficiency. When you ride your hydraulic brakes, make hard stops or have poorly adjusted brakes, this creates high temperatures and as your brakes get hotter, the more chance there is for fade or failure.

With terrain that is a series of up and down grades, the BD Exhaust Brake will aid in reducing exhaust valve warpage. Because of the power needed to pull your vehicle and load up a hill, this generates a lot of heat. When you have reached the crest of the hill and are now coasting down the other side, the heated valves are too quickly cooled. With the exhaust brake engaged, the heat loss to the valves will be reduced, which can prevent valve warpage.

When the toggle switch is turned to the "On" position, the valve is activated every time the driver takes his foot off of the throttle pedal. When the driver puts pressure back on the throttle pedal, the Micro switch is deactivated and the valve opens again. Exhaust brakes are designed to operate with the throttle at idle, not to be used in conjunction with cruise controls, and not designed to aid in gear shifting. Such cases could cause damage to engine and/or the exhaust brake. Incorporated with the BD Exhaust Brake, there is a pressure regulating system that will control the created backpressure. If the backpressure reaches the set limit, the exhaust valve will open slightly to relieve the excess pressure. **The brake pressure at idle is required to be checked and adjusted at time of installed, two weeks after installed, and on a regular twice a year interval.**

If you have purchased a system that is rated for the stock engine exhaust valve springs, and you later decide to update to the heavy duty exhaust valve springs, you will have to adjust the brake pressure to 20-25lb at idle. **Never adjust the brake to**

BD Engine Brake Inc.

Plant Address: 33541 MacLure Rd. Abbotsford, BC, Canada V2S 7W2

U.S. Shipping Address: 88-446 Harrison St, Sumas, WA 98295 U.S. Mailing Address: P.O. Box 231, Sumas, WA 98295

Phone: 604-853-6096 | Fax: 604-853-8749 | Internet: www.bd-power.com

the 60 lb. setting on an engine that has not had the heavy-duty engine exhaust valve springs installed first.

The best scenario for exhaust braking is when going down hill, select a gear that lets you maintain a constant speed with little or no use of the hydraulic brakes, or the same gear that would be used to go up the same grade of hill. This also depends on the weight, load or road conditions that the vehicle will come upon.

So, in summary, by using the BD Exhaust Brake, you reduce the need for use of your hydraulic brakes in situations where you need to slow down or maintain (i.e. hills, off ramps, corners, approaching speed changes or traffic lights). Reducing the use of your hydraulic brakes in these situations will reduce the heat build up, as well as wear and damage to linings and drums. And, when you reduce these factors, you save your hydraulic brakes for when you really need them (for stopping or emergencies).

The BD Exhaust Brake is not a substitute for your hydraulic brakes and, cannot correct or compensate for poorly maintained or misadjusted brakes. But, when you need to slow down or maintain a constant speed, the BD Exhaust Brake will be a valuable and effective tool. Exhaust Brakes are more efficient at preventing than correcting an over speed condition.

BD Engine Brake Inc.

Plant Address: 33541 MacLure Rd. Abbotsford, BC, Canada V2S 7W2

U.S. Shipping Address: 88-446 Harrison St, Sumas, WA 98295 U.S. Mailing Address: P.O. Box 231, Sumas, WA 98295

Phone: 604-853-6096 | Fax: 604-853-8749 | Internet: www.bd-power.com

Vacuum Brake Troubleshooting Guide

This guide assumes that your exhaust brake system is using a DFIV. If your system uses a microswitch for throttle activation, the operation of the spool valve is the same as with the DFIV.

When I let off the throttle nothing happens.	<u>No</u>	<u>Yes</u>
Is the DFIV powering its "brake" output when the throttle is at idle and brake switch and ignition are both on?	Check if DFIV has good power, ground and throttle signal. Check DFIV adjustment. If these things check out, but the DFIV won't power the "brake" output, the DFIV is likely faulty.	The spool valve is probably stuck. Check that it has good vacuum supply. Vacuum should switch from one outlet hose to the other when the valve actuates. If it doesn't, you can dismantle and clean the spool valve. See Spool Valve Maintenance section in this manual.
The brake comes on but there's little or no holdback	<u>No</u>	<u>Yes</u>
See if torque converter is staying locked up during deceleration. If not, the engine RPM will fall to idle when the throttle is released. The brake will be ineffective without the torque converter locked up. Check off idle brake pressure. (See back pressure chart) Are you getting maximum allowable backpressure?	Check for exhaust leaks. A small leak can result in a significant decrease in back pressure. If no leaks are found check for vacuum leaks in brake system and trucks factory vacuum system.	Try down shifting more aggressively. More RPM will give more holdback. Transmission or torque converter could be slipping internally.
Everything seems to work, but the brake valve won't open/close.	<u>No</u>	<u>Yes</u>
Check that vacuum is reaching brake vacuum cylinder?	Spool valve is likely stuck. See Spool Valve Maintenance section in this manual.	Cylinder or brake valve are seized. Remove the clevis pin on the end of the cylinder rod & see if the valve lever can be moved freely.
The valve lever can be moved freely?	Try dismantling the brake & cleaning the carbon out of it. If this does not work the brake valve will need to be replaced.	The cylinder is stuck and will need to be replaced.
The brake won't close at idle but comes on when I press the throttle	The vacuum hoses to the cylinder are reversed. Swap them front-to-back on the cylinder and everything should work.	

Questions?

Thank you for purchasing the BD Exhaust Brake, please check out our web site at www.bd-power.com for other products such as BD PressureLoc, BD TowLoc or for info on our Performance Transmissions and components please call, fax or E-mail our **BD Technical Service or Sales Department**, 8:30am to 4:30pm Pacific Time, Monday to Friday.

BD Engine Brake Inc.

Plant Address: 33541 MacLure Rd. Abbotsford, BC, Canada V2S 7W2

U.S. Shipping Address: 88-446 Harrison St, Sumas, WA 98295 U.S. Mailing Address: P.O. Box 231, Sumas, WA 98295

Phone: 604-853-6096 | Fax: 604-853-8749 | Internet: www.bd-power.com