

# ***2006-07 Dodge Cummins***

## **BD Remote Mount Exhaust Brake**

### **Installation Instructions**

**P/N# 1027330**

Serial # \_\_\_\_\_

Date Purchased \_\_\_\_\_

Purchased from \_\_\_\_\_

Installed by \_\_\_\_\_

**\*\*\* Please read this manual before starting installation. \*\*\***  
**OWNER'S MANUAL - LEAVE IN GLOVE BOX**

# TABLE OF CONTENTS

---

<b>Welcome</b> .....	<b>3</b>
<b>Kit Contents (1027330)</b> .....	<b>3</b>
<b>Pre-Installation</b> .....	<b>3</b>
<b>Special Tools Required</b> .....	<b>3</b>
<b>Accessories</b> .....	<b>3</b>
<b>Notes On Connectors</b> .....	<b>4</b>
Brake Valve Installation .....	5
Air Solenoid Installation.....	7
Air Hose Installation .....	7
<i>Air Compressor Mounting Installation</i> .....	8
Regulator Installation.....	11
<i>ECM Activation Wire Install</i> .....	12
<i>Switch Install (Required if using main toggle switch) ...</i>	13
<b>Optional Manual Shifter Switch (Push-Pull Style)</b> .....	<b>15</b>
<b>Optional Manual Shifter Switch (Rocker Switch Style)</b> .....	<b>16</b>
<i>Attaching the switch relay</i> .....	18
Wiring With The Default Toggle Switch .....	18
Wiring With The Rocker Switch (Manual Trans) ..	18
Wiring & Plumbing Diagrams .....	19
<i>Using Main Toggle Switch Only</i> .....	19
<i>Using Push/Pull Shifter Switch (Manual Trans)</i> .....	20
<i>Using Rocker Switch (Manual Trans)</i> .....	21
<b>Maintenance</b> .....	<b>22</b>
<b>Operating Guidelines</b> .....	<b>22</b>
<b>Exhaust Back Pressure Testing Air Actuated Brakes</b> .....	<b>24</b>
<b>Air Brake Troubleshooting Guide</b> .....	<b>26</b>

## Welcome

Thank you for purchasing a BD Exhaust Brake. This manual is divided into different areas to assist you with your installation and operation of your braking unit. We strongly suggest that you write down the kit and serial numbers of your unit in the spaces provided and retain this manual for any future reference.

## Kit Contents (1027330)

<b>1</b>	<b>1127038</b>	Valve Assembly	<b>1</b>	<b>1220048-C</b>	Air Solenoid Assy.
<b>1</b>	<b>1220130</b>	Regulator/Control Kit	<b>2</b>	<b>1100400</b>	4" Pipe Adapter
<b>1</b>	<b>1030129-C</b>	Compressor Kit	<b>2</b>	<b>1100404</b>	4" Marmon Clamp
<b>1</b>	<b>1220115</b>	Air Snorkel Kit	<b>1</b>	<b>1100740</b>	4" S/S Exhaust Clamp
<b>1</b>	<b>1321031</b>	Toggle Switch Kit	<b>1</b>	<b>1220100</b>	Brake Snorkel Kit

## Pre-Installation

To prevent damage to electronic components, it is recommended that you disconnect both negative battery terminals before starting.

**Please read this manual thoroughly before installing this exhaust brake.**

## Special Tools Required

- Measuring tape or ruler
- Drill with 1/8", 3/16" bits and Unibit
- Sawsall or hacksaw
- Crimping Pliers
- Test light
- 1/4" Drive Socket Set
- Small bladed flat tip screwdriver
- Welder

## Accessories

Description	Part #
Manual Transmission Push-Pull Shifter Switch Kit	<b>1300210</b>
Manual Transmission Rocker Switch Kit	<b>1030900</b>
TowLoc Transmission & Converter Package	<b>CALL</b>
X-Monitor Digital Gauge Package	<b>1085220</b>
Brake Pressure Gauge Kit	<b>1030550</b>

BD Engine Brake Inc.

Plant Address: 33541 MacLure Rd. Abbotsford, BC, Canada V2S 7W2

U.S. Shipping Address: 88-446 Harrison St, Sumas, WA 98295 U.S. Mailing Address: P.O. Box 231, Sumas, WA 98295

Phone: 604-853-6096 | Fax: 604-853-8749 | Internet: www.bd-power.com

## Notes On Connectors

The kit includes a number of Posi-Tap™ connectors (Gray or Red/Black/Green or Yellow) to tap onto OEM wiring. It is important to select the correct color of connector so that it matches the gauge of the OEM wire that it is being installed on. Using the incorrect connector could cause an inadequate connection and/or the OEM wire could be severed.

OEM Wire	Posi-Tap™ Color
18-22ga	Gray or Red
12-18ga	Black
10-12ga	Green or Yellow

Though these connectors offer a quicker installation, the best option would be to solder the wires and isolate the joints with heat shrink or liquid electrical tape. Proper soldering techniques should be used to ensure adequate connections.

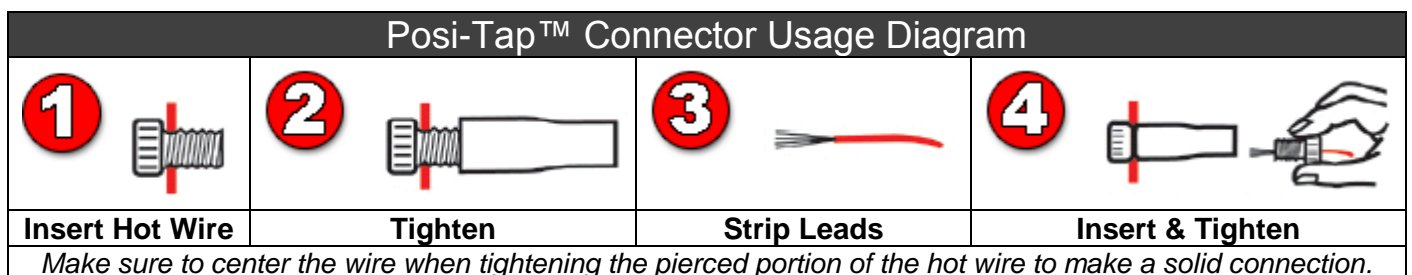

**The ground terminals of the vehicle's batteries should be disconnected before performing any piercing/posi-tapping onto any ECM/PCM wire.**

## Brake Valve Installation

**\*SAFETY\*:** To prevent injury or damage raise the vehicle to a good working height with either a hoist or proper jack stands.

From underneath the vehicle, locate the turbo down pipe and the catalytic converter. You will need to cut a 7-1/4" section from this pipe. Although the pipe has a number of unusual bends, you will need to choose the straightest section possible, especially for the rear adapter of the brake, as this is a SS band clamp. As well mock up the installation of the brake so that when the brake cycles, the actuator will not come in contact with anything. Use a Sawsall or cutting disc to remove this section.

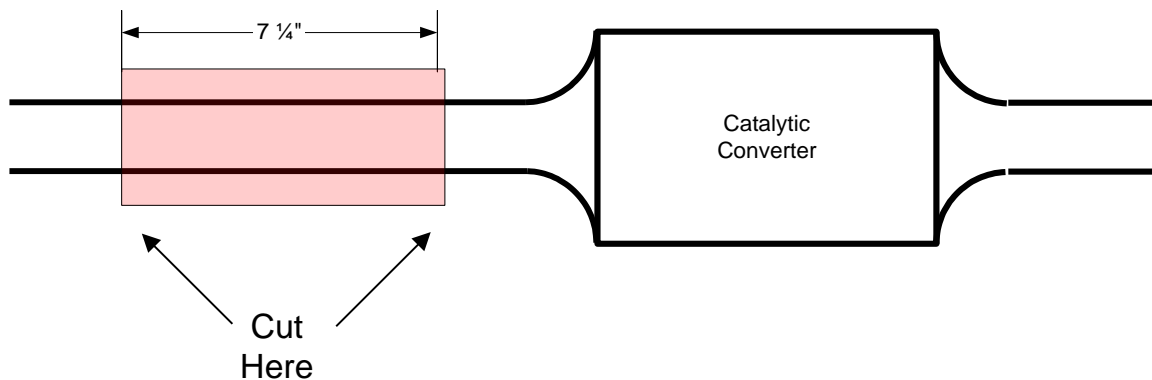

Clean off the cut ends of the intermediate pipe with a file to remove burrs left from cutting and then insert the adapter pipes onto each end of the now exposed pipes.

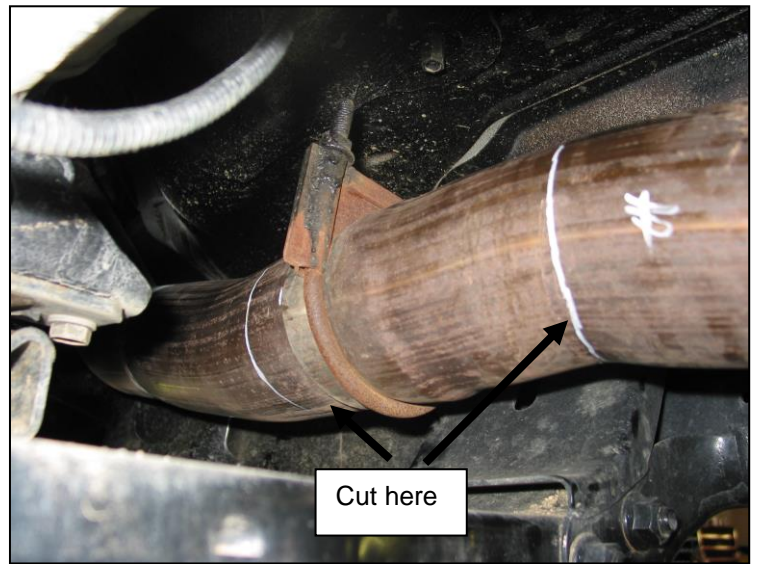

BD Engine Brake Inc.

Plant Address: 33541 MacLure Rd. Abbotsford, BC, Canada V2S 7W2

U.S. Shipping Address: 88-446 Harrison St, Sumas, WA 98295 U.S. Mailing Address: P.O. Box 231, Sumas, WA 98295

Phone: 604-853-6096 | Fax: 604-853-8749 | Internet: [www.bd-power.com](http://www.bd-power.com)

Insert the exhaust brake and secure with supplied 'V' band clamps. Be sure that the air cylinder bracket extends toward the rear of the vehicle.

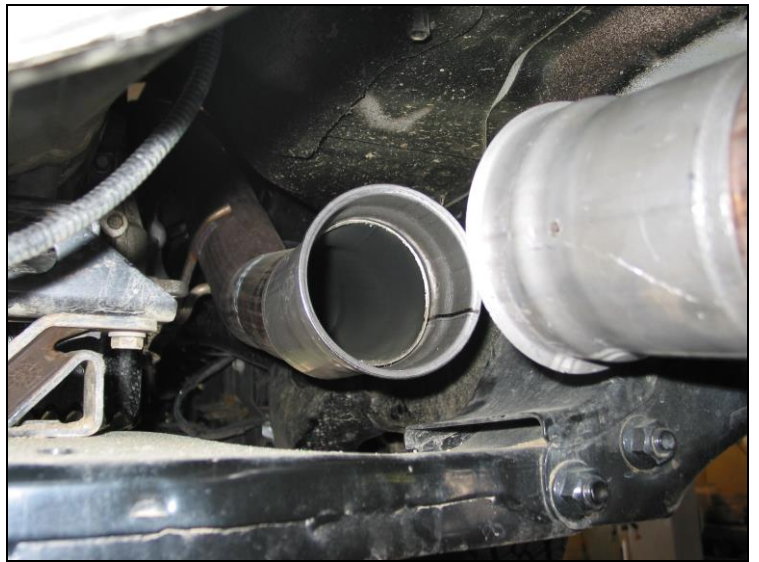

Ensure the exhaust brake and rear exhaust sections are pushed all the way forward on the front pipe so that the front adapter flange is up against the stop that is on top of the front pipe section then WELD the front adapter in place. Install the rear adapter to the pipe using the supplied band clamp.

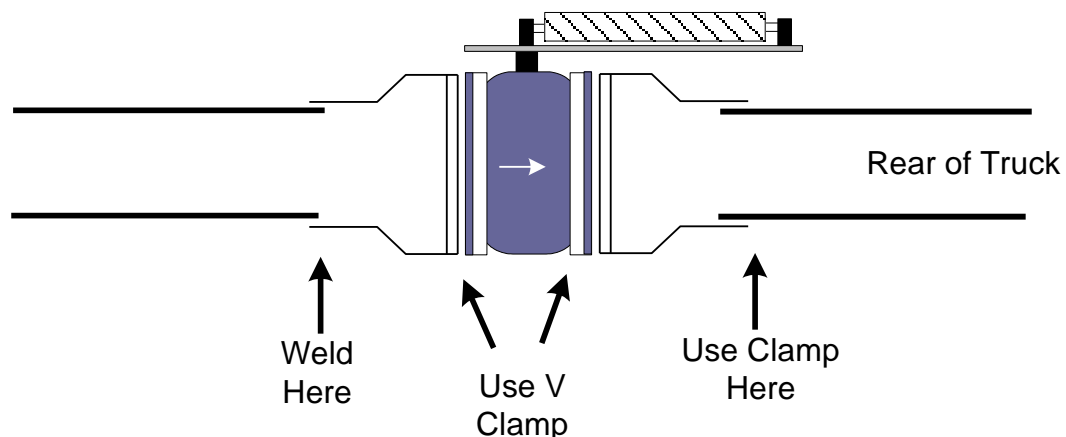

**NOTE:** SECURING THE FRONT ADAPTER WITH JUST A CLAMP WILL CAUSE LEAKAGE AND NOT ALLOW THE BRAKE TO OBTAIN FULL BRAKING PRESSURE.

BD Engine Brake Inc.

Plant Address: 33541 MacLure Rd. Abbotsford, BC, Canada V2S 7W2

U.S. Shipping Address: 88-446 Harrison St, Sumas, WA 98295 U.S. Mailing Address: P.O. Box 231, Sumas, WA 98295

Phone: 604-853-6096 | Fax: 604-853-8749 | Internet: [www.bd-power.com](http://www.bd-power.com)

## Air Solenoid Installation

Just across from the exhaust brake on the passenger side frame rail you will notice a number of factory holes in the frame. Utilize one of these holes to mount the air solenoid assembly. Make sure the air solenoid is as close as possible to the exhaust brake to ensure quick engagement and disengagement of the brake. Mount the air solenoid using the supplied hardware.

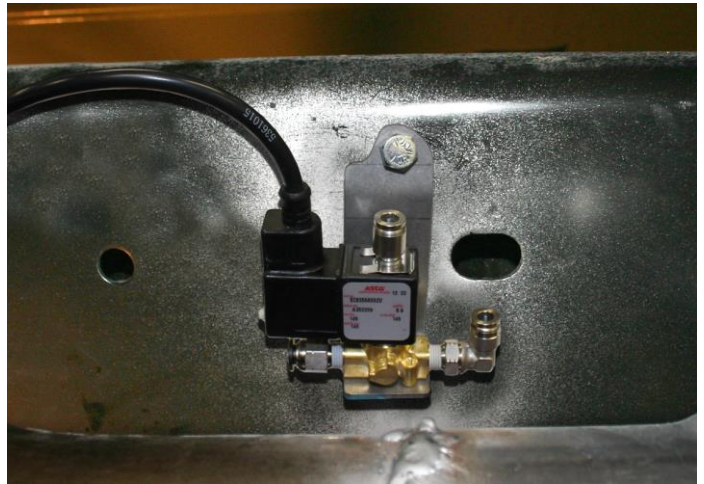

## Air Hose Installation

Insert one end of the 1/4" plastic hose supplied in the 1220100 Snorkel kit into the quick-connect coupler on the quick release valve on the brake air cylinder and route it over to the 90° fitting on the #1 port of the solenoid valve.

Cut the hose with a knife or a hose cutter, leaving some slack for routing (do NOT use side cutting pliers as the hose will be squashed and leak). Ensure the end is cleaned of any burrs.

Insert the remaining length of hose (with the filter attached) into the 90° fitting on the front of the brake air cylinder (the end of the cylinder where the rod comes out) and route it over to the air solenoid.

As indicated by the photo, secure the plastic hose by installing the clamps provided to the body of the cab. Drill a 1/8" pilot hole in the cab body as shown in the photo and secure the anchor clamps with the provided self-tapping screw.

Next install the 1220115 hose & wire assembly onto the air solenoid. The hose that is open on both ends is attached to the straight fitting in the #2 port of the air solenoid. The open end of the hose with the filter on it is installed onto the fitting coming out the top of the air solenoid. Use the provided crimp connectors with the clear heat shrink on them to connect the red wire in the hose assembly to the blue wire on the air solenoid and the black wire in the hose assembly to the brown wire on the air solenoid. Route this assembly, and the snorkel you installed on the air cylinder, up into the engine bay.

**CARE MUST BE TAKEN NOT TO KINK THE PLASTIC HOSE OR ROUTE IT NEAR A HEAT SOURCE.**

BD Engine Brake Inc.

Plant Address: 33541 MacLure Rd. Abbotsford, BC, Canada V2S 7W2

U.S. Shipping Address: 88-446 Harrison St, Sumas, WA 98295 U.S. Mailing Address: P.O. Box 231, Sumas, WA 98295

Phone: 604-853-6096 | Fax: 604-853-8749 | Internet: [www.bd-power.com](http://www.bd-power.com)

**NOTE:** Removal of the plastic hose from the quick coupler is accomplished by pushing the colored ring toward the fitting and pulling the hose out.

REFER TO THE WIRING DIAGRAMS FOR CORRECT HOOK UP OF HOSES AND WIRING.

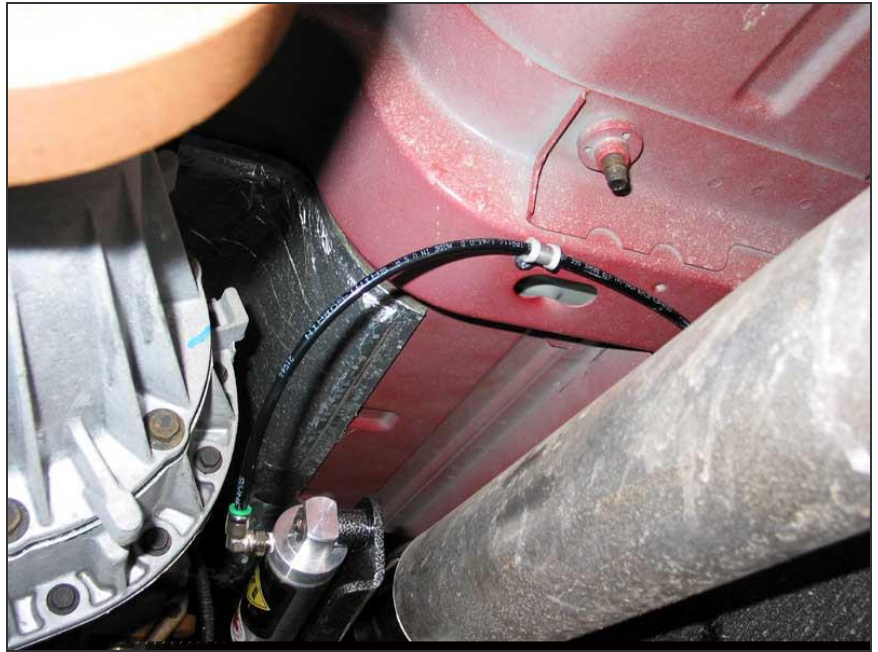

### ***Air Compressor Mounting Installation***

You will need to remove the inner front fender well on the passenger side of the vehicle. There are eight bolts holding the lining in place. If you can put the vehicle on a hoist about 3 feet above the ground it will ease this installation.

Locate the hood support bolt up inside of the fender well; it is very close to the bottom of the radio antenna. Remove the bolt closest to the battery tray or closest to the front of the vehicle.

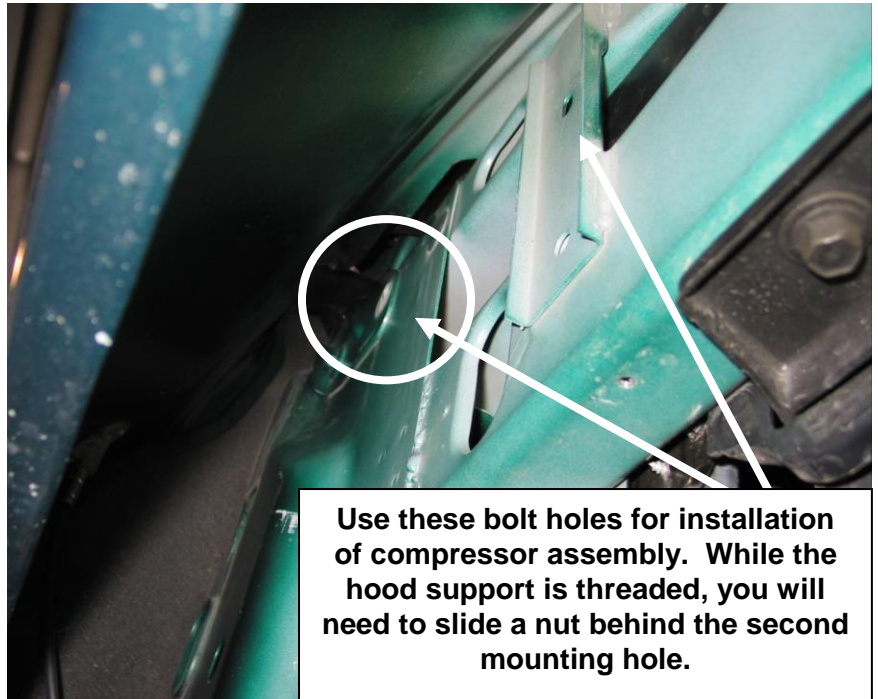

**Use these bolt holes for installation of compressor assembly. While the hood support is threaded, you will need to slide a nut behind the second mounting hole.**

BD Engine Brake Inc.

Plant Address: 33541 MacLure Rd. Abbotsford, BC, Canada V2S 7W2

U.S. Shipping Address: 88-446 Harrison St, Sumas, WA 98295 U.S. Mailing Address: P.O. Box 231, Sumas, WA 98295

Phone: 604-853-6096 | Fax: 604-853-8749 | Internet: [www.bd-power.com](http://www.bd-power.com)



Attach the foam tape to the bottom backside of the bracket.

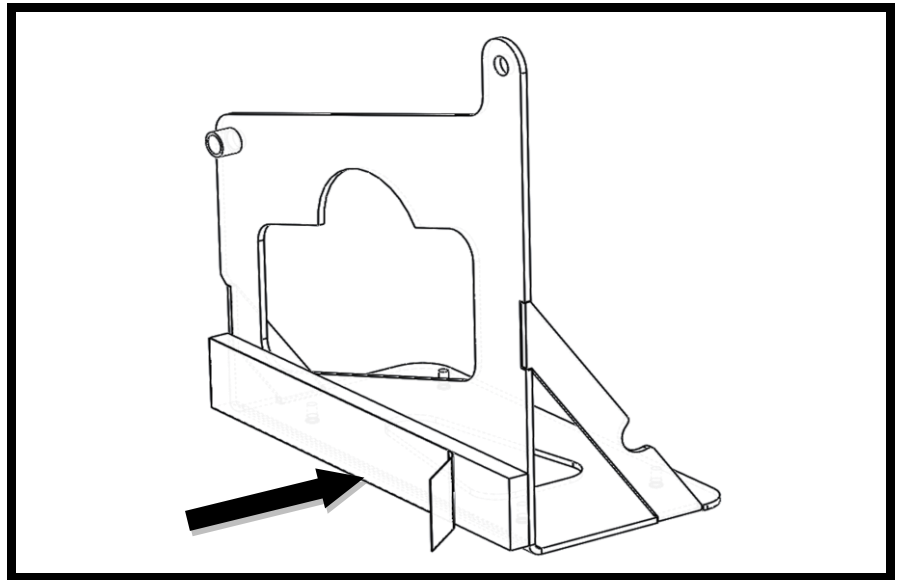

Slide the compressor assembly up into this space and re-install the hood support bolt. Now raise the compressor assembly so that you can install the provided bolt through the bracket and frame hole into the nut. Note that you can use a magnet to assist in holding this nut in place while you slide the bolt through.



BD Engine Brake Inc.

Plant Address: 33541 MacLure Rd. Abbotsford, BC, Canada V2S 7W2

U.S. Shipping Address: 88-446 Harrison St, Sumas, WA 98295 U.S. Mailing Address: P.O. Box 231, Sumas, WA 98295

Phone: 604-853-6096 | Fax: 604-853-8749 | Internet: [www.bd-power.com](http://www.bd-power.com)

Tighten all bolts to secure the assembly. Route the compressor hoses & wiring harness up through the body opening at the rear of the battery. They will be hooked up later.

Use the wiring diagram on page 19 as a reference for the wiring of the air hoses and the electrical wiring. NOTE: Be sure to keep all hoses and wiring harnesses away from any moving parts or heat sources.

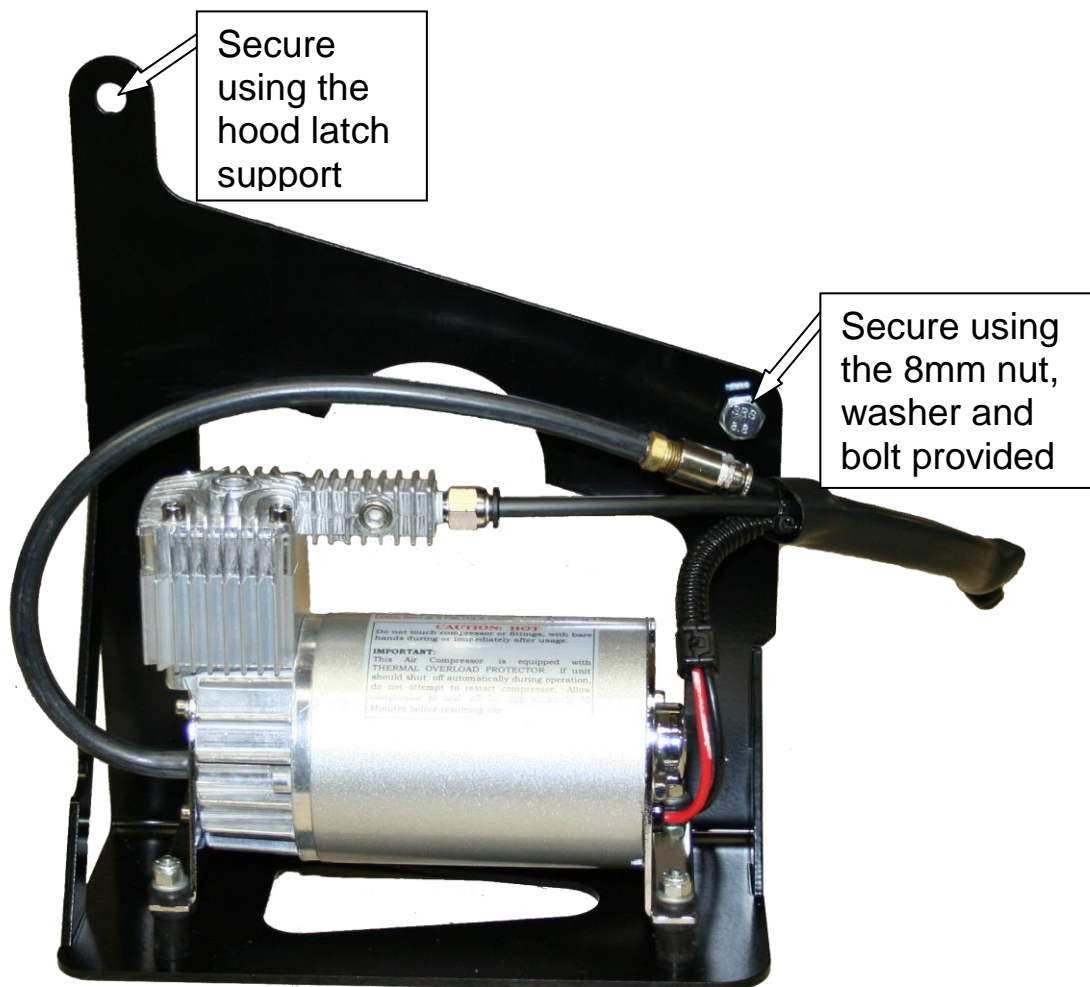
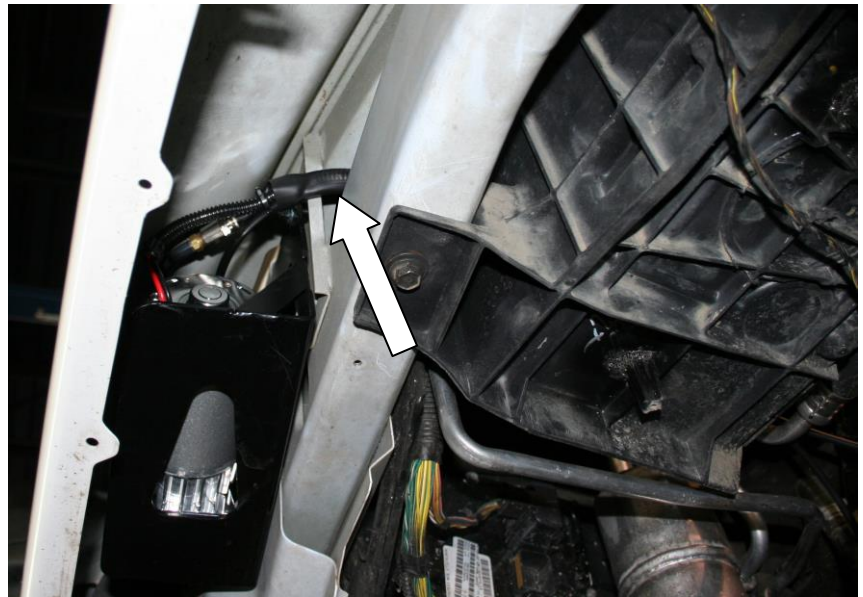

## Regulator Installation

Locate the large oval hole on the passenger side of the vehicle near the upper cowling of the firewall. To the right of this you can either drill a 3/8" hole or use the existing hole by removing the factory plastic locking insert.

Install the regulator assembly underneath the hole (shown on figure to the right). The lock washer and flat washer should be installed on top of the plastic cowling with the Phillips screw holding everything in place.

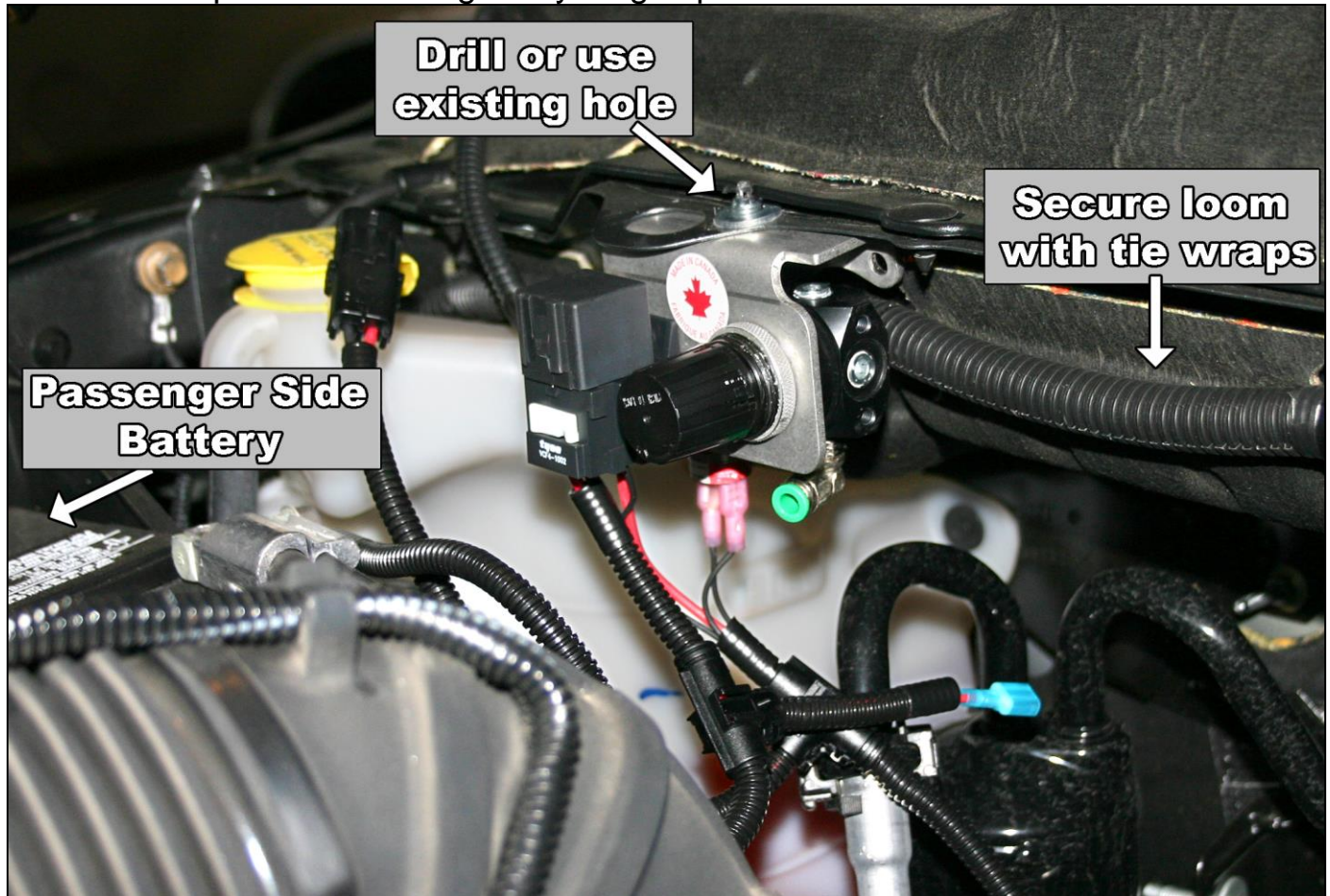

Now hook up the wiring harness on the regulator assembly:

Attach the ring terminal on the red wire with the fuse holder in it to the positive terminal of the passenger side battery. Connect the ring terminal on the black wire to the negative terminal. Connect the red and black wires from the air solenoid hose & wire harness to the corresponding connectors on the regulator assembly harness. Connect the female 2-pin connector to the corresponding male connector on the air pump.

And finish the pump install:

Run the hose from the pump outlet (coming out of the pump head) to the INLET fitting on the regulator. Run the inlet hose for the air pump (going into the front body of the pump) to a clean, dry location in the engine bay. Install the grey "pancake" filter onto the end of the hose. There are also two spare filter elements provided for future use. Reinstall the fender liner.

BD Engine Brake Inc.

Plant Address: 33541 MacLure Rd. Abbotsford, BC, Canada V2S 7W2

U.S. Shipping Address: 88-446 Harrison St, Sumas, WA 98295 U.S. Mailing Address: P.O. Box 231, Sumas, WA 98295

Phone: 604-853-6096 | Fax: 604-853-8749 | Internet: [www.bd-power.com](http://www.bd-power.com)

### ECM Activation Wire Install

There are two separate ECM wiring blocks on the ECM, located on the driver's side of the engine – one 60-pin connector and a 50-pin connector.

Remove the 50-pin connector (#3 on picture to the right).

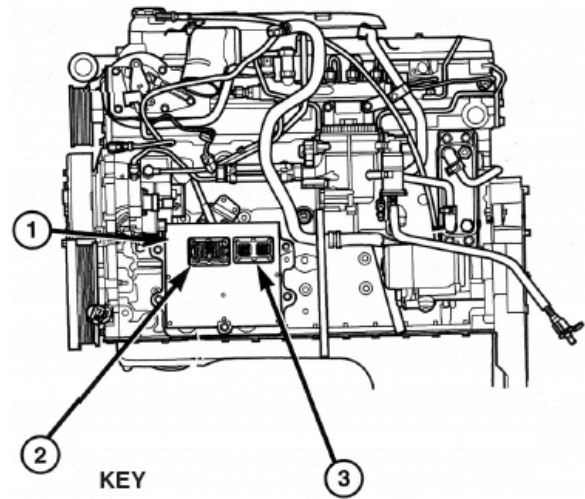

KEY

- 1. Engine Control Module (ECM)
- 2. 60-Way Connector
- 3. 50-Way Connector

Locate Pin #39 (for the activation wire from the cab) and Pin #42 (for the black wire in the control harness). These pins have a plug in them from the factory, which will have to be removed.

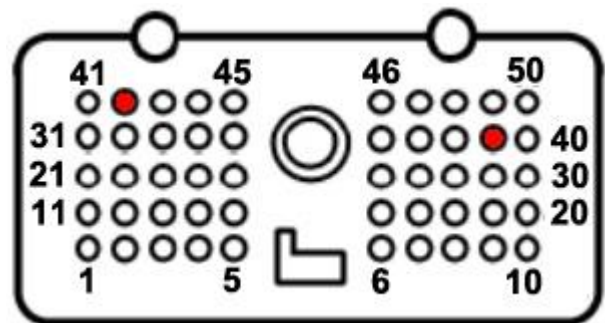

For this step you will need a pair of needle-nose pliers and a paper clip. Bend out the paper clip enough so that there is a straight shaft.

The easiest way to remove the OEM plug pins is to take the paper clip and insert it into the bottom end of the pin connector hole. This will poke out the top of the plug which then can be removed with pliers.

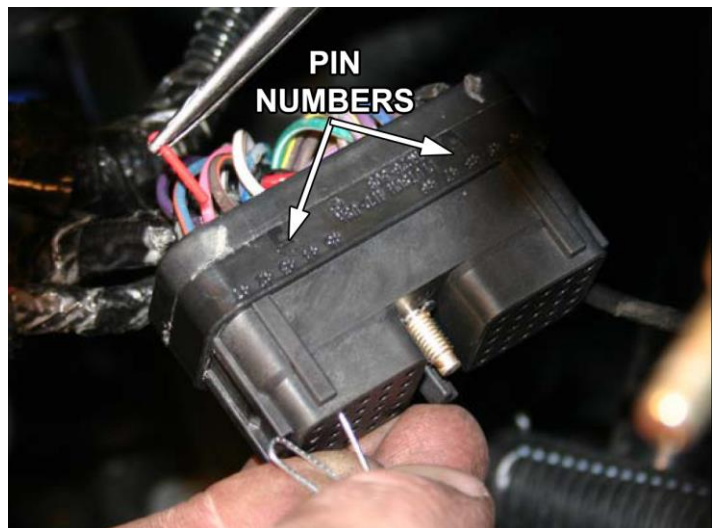

The two wire leads from the regulator assembly harness (with the ECM pins pre-crimped) can now be plugged into the ECM. Insert the tan wire into Pin #39, and the black wire to Pin #42. They should snap into place. Once this is complete, you can re-install the ECM plug. Secure the wiring loom using the supplied tie wraps.

### **Switch Install (Required if using main toggle switch)**

Remove attaching screws of the dashboard bezel and remove covering trim by pulling rearward on the corners of the trim panels.



**Note:** Placing the transmission all the way into 1<sup>st</sup>/low gear and ensuring the tilt steering is all the way down will allow for easy removal.

Pull the left hand and right hand dash panels away from their secured positions and let them hang.



Once the dash trim has been removed place it on a large working surface like a table or workbench.

Measure and mark a spot for the Toggle Switch 3/4" up from the bottom edge of the dash panel and 1" in from the left edge of the accessory panel as shown in the photo.

Drill a pilot hole with a 1/8" bit and finish by enlarging the hole with a Unibit to exactly 1/2".

**NOTE:** YOU MAY HAVE TO GRIND DOWN PART OF THE SUPPORT RIB ON THE BACK OF THE TRIM PANEL TO ACCOMMODATE THE SWITCH BODY.

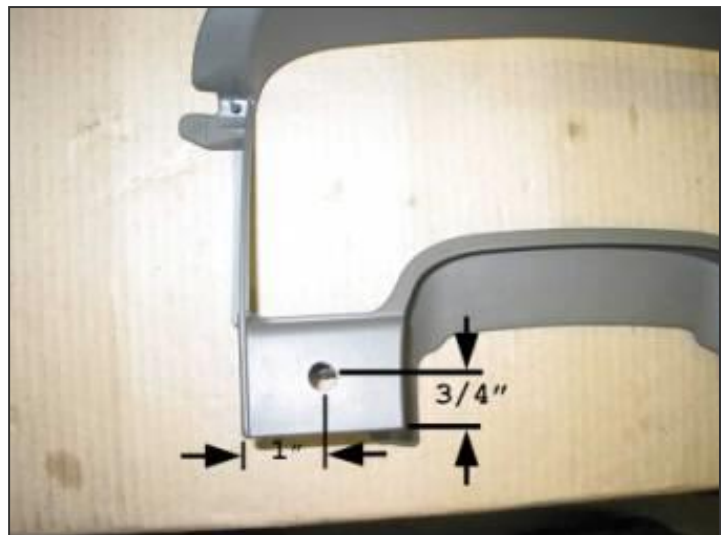

BD Engine Brake Inc.

Plant Address: 33541 MacLure Rd. Abbotsford, BC, Canada V2S 7W2

U.S. Shipping Address: 88-446 Harrison St, Sumas, WA 98295 U.S. Mailing Address: P.O. Box 231, Sumas, WA 98295

Phone: 604-853-6096 | Fax: 604-853-8749 | Internet: www.bd-power.com



Install the switch into the drilled hole and secure it with the plastic lock ring. Reinstall the dash trim panels by reversing the removal procedure.

Once the switch is installed, attach the ground wire to a good metal ground under the dash.

With a test light, locate a switched 12 Volt power source (quite frequently a pink w/ white tracer wire) and install the supplied black (12-18ga) Posi-Tap™ to it then attach the red fused wire from the switch to this Posi-Tap™.

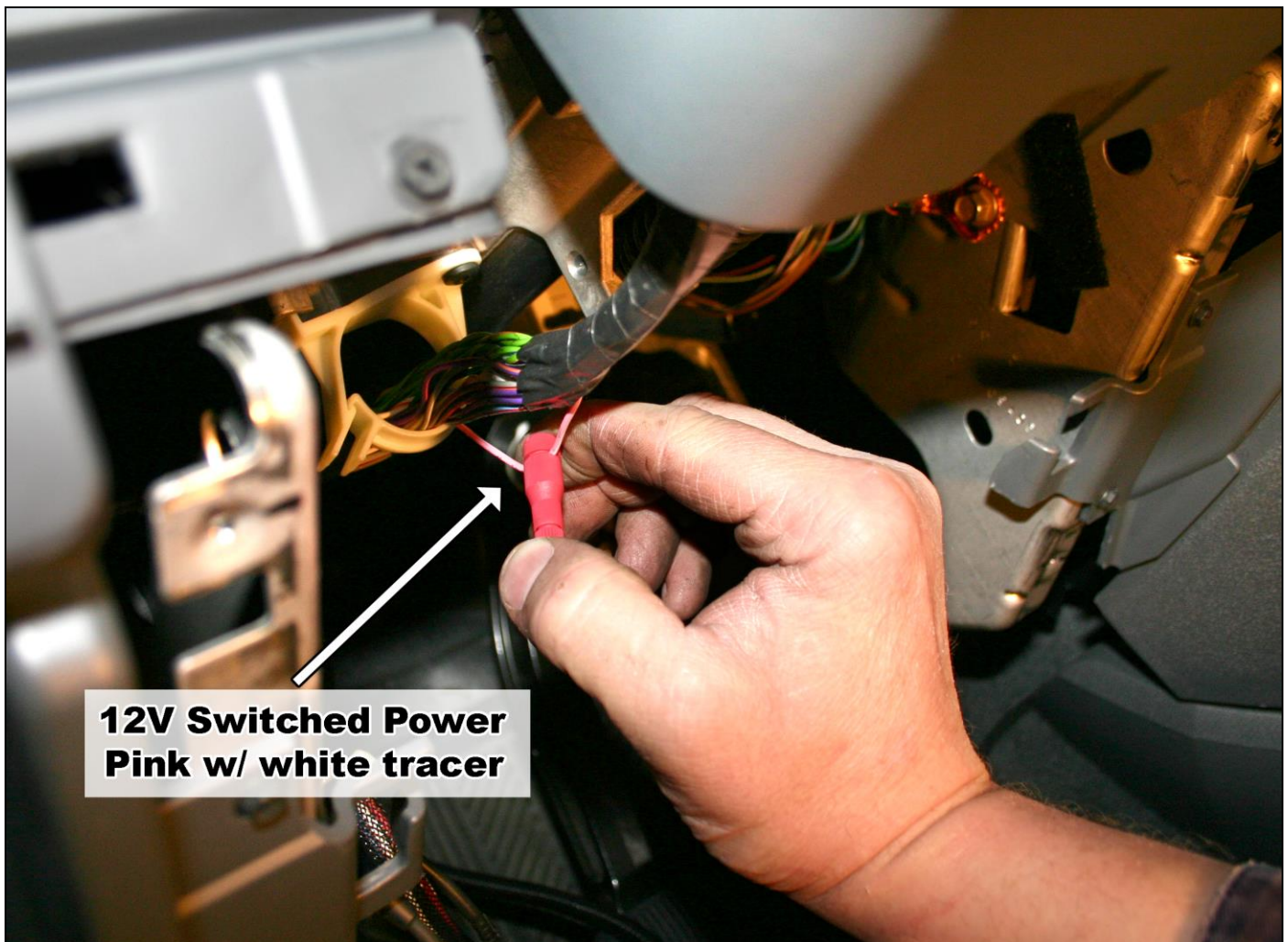

**12V Switched Power  
Pink w/ white tracer**

BD Engine Brake Inc.

Plant Address: 33541 MacLure Rd. Abbotsford, BC, Canada V2S 7W2

U.S. Shipping Address: 88-446 Harrison St, Sumas, WA 98295 U.S. Mailing Address: P.O. Box 231, Sumas, WA 98295

Phone: 604-853-6096 | Fax: 604-853-8749 | Internet: [www.bd-power.com](http://www.bd-power.com)

### ***Optional Manual Shifter Switch (Push-Pull Style)***

Mount the shifter switch onto the shift lever using the clamp supplied (either 5/8" or 3/4").

Run the electrical cable down the shifter shaft, securing the cable with zip-ties or electrical tape, and run it under the carpet to the firewall and under the dash leaving enough slack for proper shifting of the transmission lever and to prevent any rubbing of wire.

At the end of the cable, cut off any excess and strip away about 1 to 2 inches of the black rubber covering exposing the black and white (or green) wires, and then strip the insulation from the ends of the two wires.



Connect the white (or green) wire to the Tan brake activation wire leading to the ECM. Connect the black wire to a nearby ground source. See page 15 for wiring diagram.

BD Engine Brake Inc.

Plant Address: 33541 MacLure Rd. Abbotsford, BC, Canada V2S 7W2

U.S. Shipping Address: 88-446 Harrison St, Sumas, WA 98295 U.S. Mailing Address: P.O. Box 231, Sumas, WA 98295

Phone: 604-853-6096 | Fax: 604-853-8749 | Internet: [www.bd-power.com](http://www.bd-power.com)

## Optional Manual Shifter Switch (Rocker Switch Style)

Mount the shifter switch onto the shift lever using the clamp supplied (either 5/8" or 3/4"). Run the electrical cable down the shifter shaft, securing the cable with zip-ties or electrical tape, and run it under the carpet to the firewall and under the dash, leaving enough slack for proper shifting of the transmission lever and to prevent any rubbing of wire.

At the end of the cable, cut off any excess and strip away about 1-2" of the black rubber insulation exposing the black, white and green wires, then strip the insulation from the ends of the three wires.

Due to the characteristics of running the exhaust brake controls through the ECM, a relay kit has to be installed (unless you are installing the push-pull switch for the manual transmissions). This is so the light on the toggle switch (or rocker switch for the manual transmissions) can be lit while the exhaust brake is engaged. This relay comes pre-wired from the factory and is included in the main toggle switch kit. Connect the tan wire coming from the ECM to terminal #87 on the relay. Connect the green wire leading from the switch to terminal #85 on the relay

Connect the green 12V output green wire to #85 on the relay, which then leads to the Tan brake activation wire going to the ECM.

Attach the 5/16" ring connector to the black ground wire and attach it to a good ground nearby.

Locate one of the ignition switched power fuses in the fuse panel underneath the steering column. Traditionally this wire will be pink with a white tracer. Use a voltmeter to check the voltage of the wire. Use the supplied fuse tap to supply

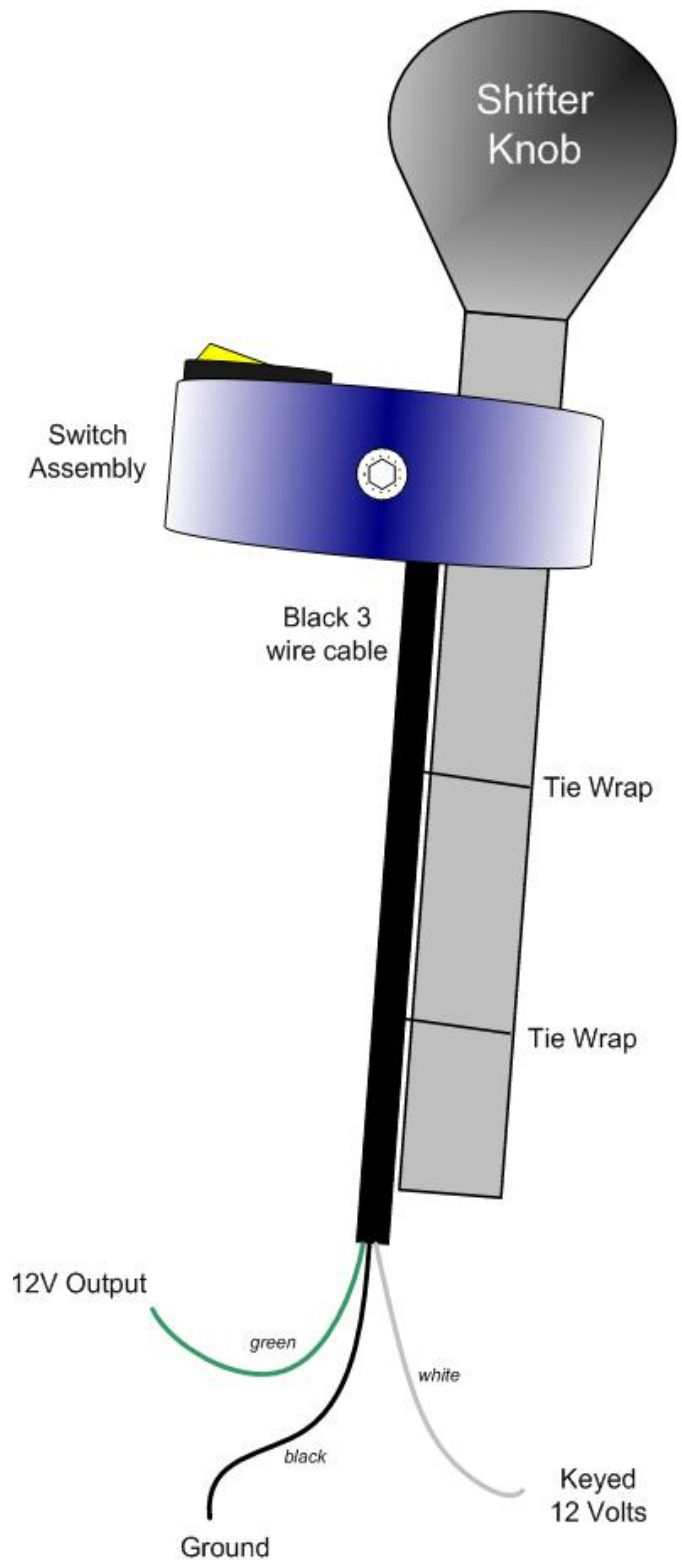

BD Engine Brake Inc.

Plant Address: 33541 MacLure Rd. Abbotsford, BC, Canada V2S 7W2

U.S. Shipping Address: 88-446 Harrison St, Sumas, WA 98295 U.S. Mailing Address: P.O. Box 231, Sumas, WA 98295

Phone: 604-853-6096 | Fax: 604-853-8749 | Internet: www.bd-power.com



ignition switched power to the “Keyed 12 Volts” (white) wire of the rocker switch assembly.

BD Engine Brake Inc.

Plant Address: 33541 MacLure Rd. Abbotsford, BC, Canada V2S 7W2

U.S. Shipping Address: 88-446 Harrison St, Sumas, WA 98295 U.S. Mailing Address: P.O. Box 231, Sumas, WA 98295

Phone: 604-853-6096 | Fax: 604-853-8749 | Internet: [www.bd-power.com](http://www.bd-power.com)

## ***Attaching the switch relay***

Due to the characteristics of running the exhaust brake controls through the ECM, a relay kit has to be installed (unless you are installing the push-pull switch for the manual transmissions). This is so the light on the toggle switch (or rocker switch for the manual transmissions) can be lit while the exhaust brake is engaged. This relay comes pre-wired from the factory and is included in the main toggle switch kit.

Connect the tan wire coming from the ECM to terminal #87 on the relay. Connect the green wire leading from the switch to terminal #85 on the relay. Connect the black Y-wire to a ground source nearby. Blade terminals have been included loose in the bag, but not pre-crimped, so you can strip the wire to the desired length.

### ***Wiring With The Default Toggle Switch***

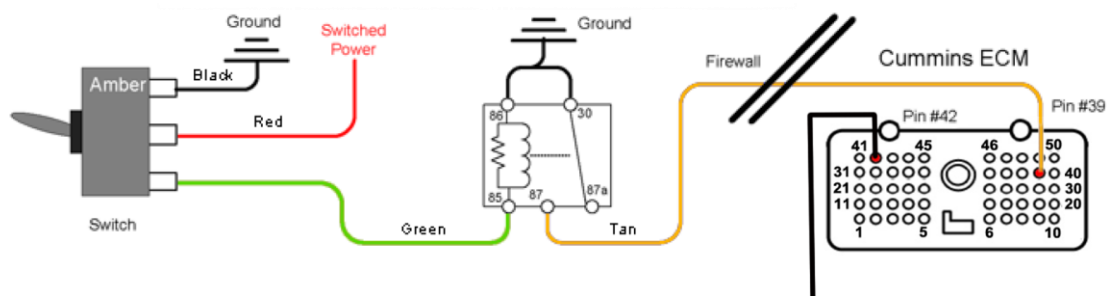

### ***Wiring With The Rocker Switch (Manual Trans)***

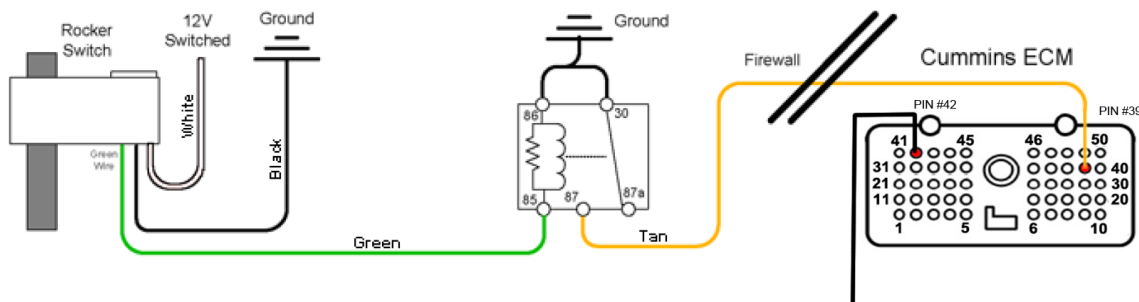

This switch relay is **not required** when wiring the exhaust brake with the push-pull style switch.

BD Engine Brake Inc.

Plant Address: 33541 MacLure Rd. Abbotsford, BC, Canada V2S 7W2

U.S. Shipping Address: 88-446 Harrison St, Sumas, WA 98295 U.S. Mailing Address: P.O. Box 231, Sumas, WA 98295

Phone: 604-853-6096 | Fax: 604-853-8749 | Internet: [www.bd-power.com](http://www.bd-power.com)

# Wiring & Plumbing Diagrams

## Using Main Toggle Switch Only

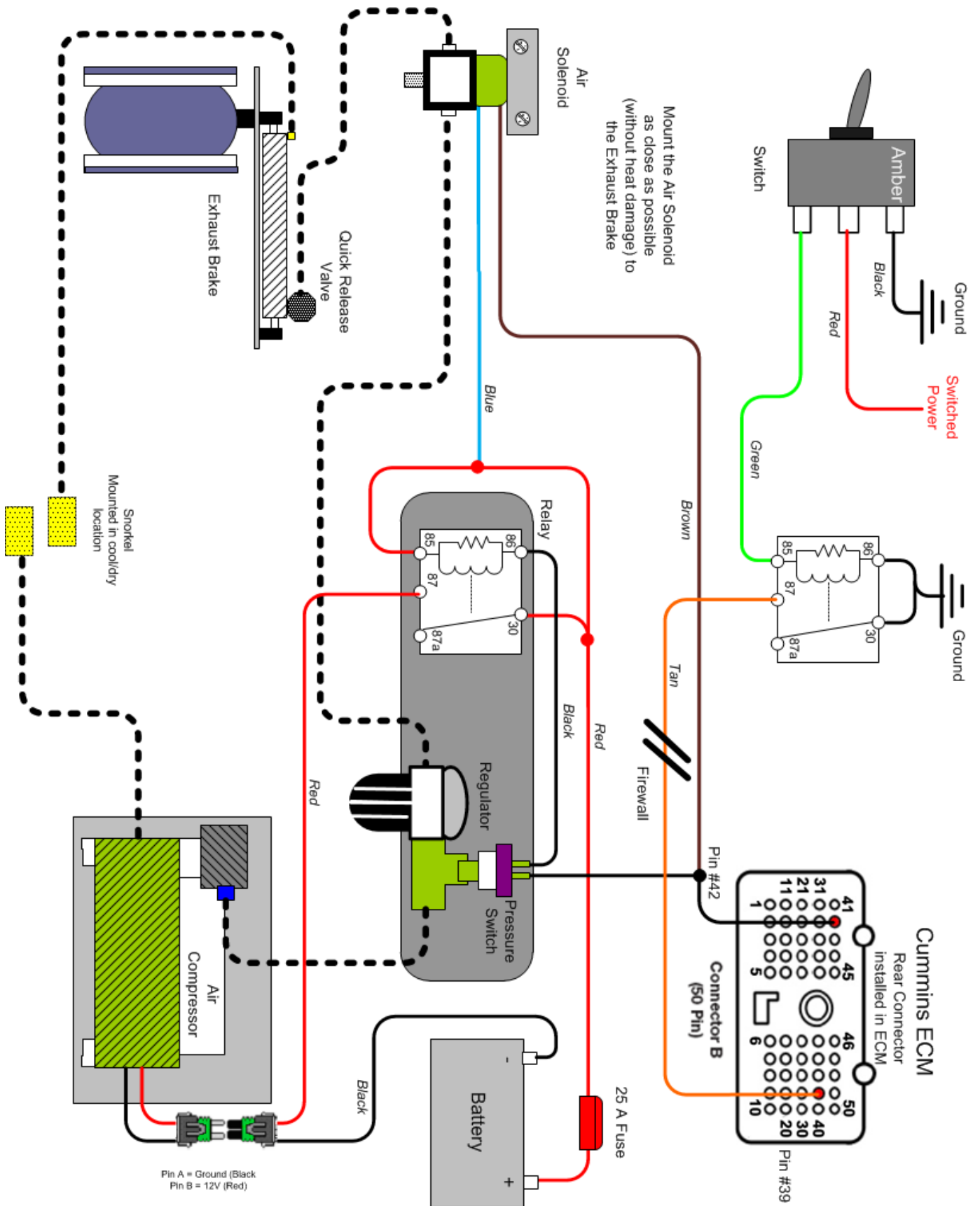

BD Engine Brake Inc.

Plant Address: 33541 MacLure Rd. Abbotsford, BC, Canada V2S 7W2

U.S. Shipping Address: 88-446 Harrison St, Sumas, WA 98295 U.S. Mailing Address: P.O. Box 231, Sumas, WA 98295

Phone: 604-853-6096 | Fax: 604-853-8749 | Internet: www.bd-power.com

### Using Push/Pull Shifter Switch (Manual Trans)

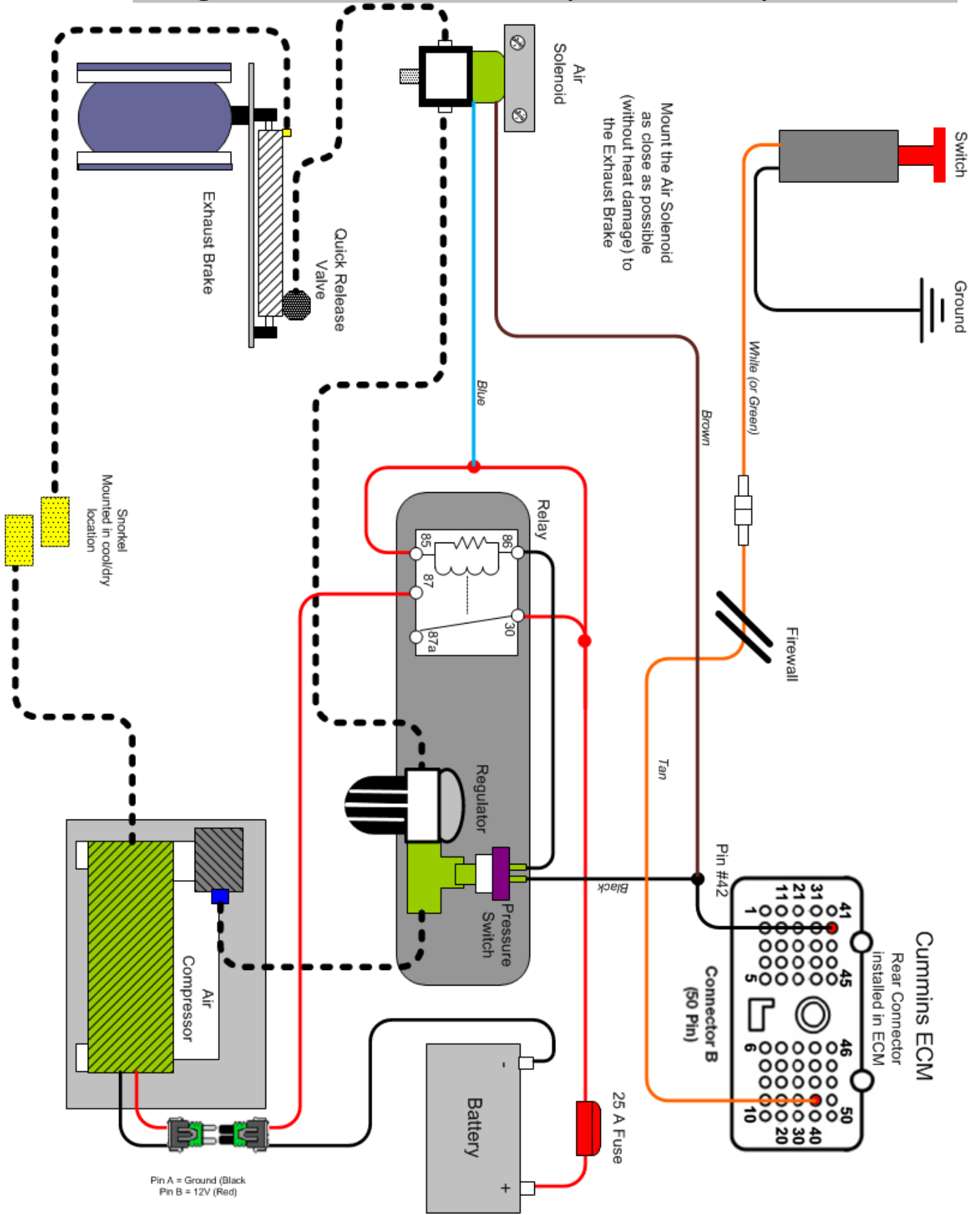

BD Engine Brake Inc.

Plant Address: 33541 MacLure Rd. Abbotsford, BC, Canada V2S 7W2

U.S. Shipping Address: 88-446 Harrison St, Sumas, WA 98295 U.S. Mailing Address: P.O. Box 231, Sumas, WA 98295

Phone: 604-853-6096 | Fax: 604-853-8749 | Internet: www.bd-power.com

# Using Rocker Switch (Manual Trans)

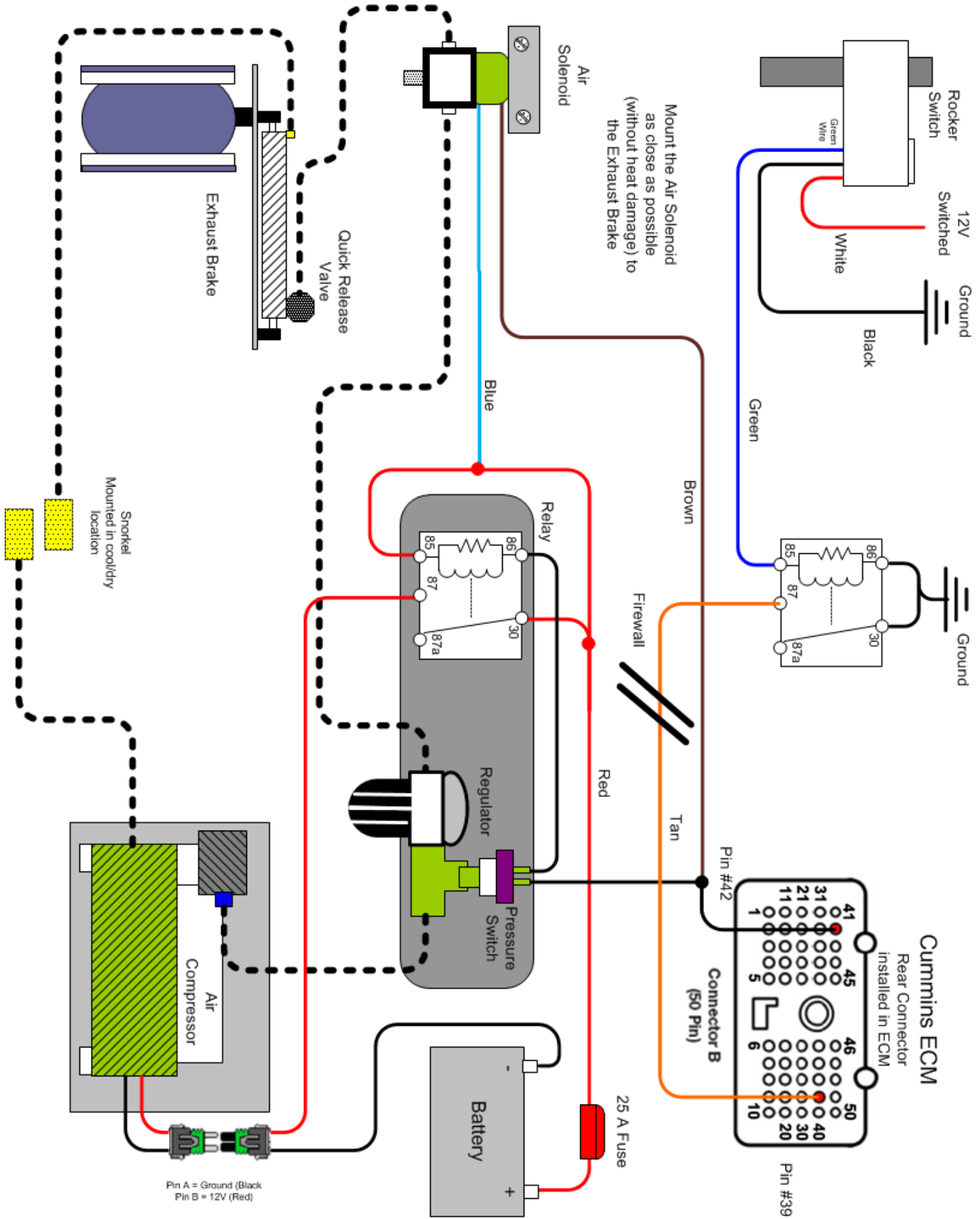

BD Engine Brake Inc.

Plant Address: 33541 MacLure Rd. Abbotsford, BC, Canada V2S 7W2

U.S. Shipping Address: 88-446 Harrison St, Sumas, WA 98295 U.S. Mailing Address: P.O. Box 231, Sumas, WA 98295

Phone: 604-853-6096 | Fax: 604-853-8749 | Internet: www.bd-power.com

## Maintenance

To extend life of the exhaust brake, do not operate the vehicle for extended periods of time without activating the brake. We suggest activating the exhaust brake at least a couple times a day while operating the vehicle to prevent any carbon or rust build up on inner parts of the brake valve assembly.

The hoses, wires, fittings and clamps should be inspected on a regular basis for any deterioration, damage or leaks.

**To increase the life of your exhaust brake, we recommend daily operation. By simply switching the brake on and off a couple times a day, it will prevent the butterfly valve from sticking due to carbon build-up.**

Following the diagrams in this manual, tracing hoses and wiring, checking continuity through electric components or checking for any lines that are disconnected, should solve any problems that may arise. If you have any problems or need replacement parts, call us at 1-800-887-5030, between 8:30am and 5:00pm Pacific Time.

## Operating Guidelines

Thank you for taking interest in the BD Engine Exhaust Brake. As a driver, you probably already know the need for extra braking power that your vehicle requires on the hills and long grades. With loads being towed behind you, the extra push when slowing down or maintaining speed on downward grades can prove to be a great strain on your vehicles hydraulic braking system, even to the point of “burn-up”. These guidelines were designed to offer you a better understanding of the benefits of exhaust brakes and are partly based upon material developed by the U.S. Department of Transportation National Highway Traffic Safety Administration.

The emphasis on today’s vehicles is to give the consumer a product that can give them usable power with fuel efficiency. But, in the transition, the vehicles have lost their natural braking power, making it more easy for the vehicle to continue to roll and harder to stop. Of course, this gets more noticeable with the increase of weight, on or behind the vehicle. This is where an exhaust brake becomes a useful tool in increasing the driveline drag of the vehicle without the use of the hydraulic brakes; a tool that with maximum use or even occasional use can reduce wear on hydraulic braking parts and at the same time increase safety.

The BD Exhaust Brake can be used to help maintain a controlled vehicle speed on a downward grade, as well as slowing the vehicle down for such times as turns or exit ramps, without you using your hydraulic brakes. **But, the exhaust brake cannot be used as a parking brake or will not bring your vehicle to a complete stop.** By using a BD Exhaust Brake, the life and effectiveness of your hydraulic brakes will increase.

BD Engine Brake Inc.

Plant Address: 33541 MacLure Rd. Abbotsford, BC, Canada V2S 7W2

U.S. Shipping Address: 88-446 Harrison St, Sumas, WA 98295 U.S. Mailing Address: P.O. Box 231, Sumas, WA 98295

Phone: 604-853-6096 | Fax: 604-853-8749 | Internet: www.bd-power.com

This is because of the decreased use of the hydraulic brakes in situations like hills, the wear factor is reduced and there is less opportunity for your hydraulic brakes to heat up which would reduce the efficiency. When you ride your hydraulic brakes, make hard stops or have poorly adjusted brakes, this creates high temperatures and as your brakes get hotter, the more chance there is for failure.

With terrain that is a series of up and down grades, the BD Exhaust Brake will help reduce warping in the exhaust valves. Because of the power needed to pull your vehicle and load up a hill, this generates a lot of heat. When you have reached the crest of the hill and are coasting down the other side, the heated valves are cooled too quickly. With the exhaust brake engaged, the heat loss to the valves will be reduced, which can prevent valve warping.

When the toggle switch is turned to the "On" position, the valve is activated every time the driver takes his foot off of the throttle pedal. When the driver puts pressure back on the throttle pedal, the DFIV/switch is deactivated and the valve opens again.

Exhaust brakes are designed to operate with the throttle at idle - not to be used in conjunction with cruise controls, and not designed to aid in gear shifting.

Such cases may cause damage to engine and/or exhaust brake. There is a pressure regulating system incorporated with the BD Exhaust Brake that will control the created backpressure. If the backpressure reaches the set limit while under engine braking, the exhaust valve will open slightly to relieve the excess pressure.

The best scenario for exhaust braking is when going down hill, select a gear that lets you maintain a constant speed with little or no use of the hydraulic brakes, or the same gear that would be used to go up the same grade of hill. This also depends on the weight, load or road conditions that the vehicle will come upon. So, in summary, by using the BD Exhaust Brake, you reduce the need for use of your hydraulic brakes in situations where you need to slow down or maintain (i.e. hills, off ramps, corners, approaching speed changes or traffic lights). Reducing the use of your hydraulic brakes in these situations will reduce the heat build up, as well as wear and damage to linings and drums. And, when you reduce these factors, you save your hydraulic brakes for when you really need them (for stopping or emergencies).

The BD Exhaust Brake is not a substitute for your hydraulic brakes and, cannot correct or compensate for poorly maintained or misadjusted brakes. But, when you need to slow down or maintain a constant speed, the BD Exhaust Brake will be a valuable and effective tool. Exhaust Brakes are more efficient at preventing rather than correcting an over speed condition.

## ***Exhaust Back Pressure Testing Air Actuated Brakes***

***It is recommend that you purchase the BD pressure gauge kit #1030050***



***NOTE: The brake stop-bolt and regulator have been preset at the factory and should not need to be adjusted.***

***You do not need to measure the air pressure in the system, just the exhaust backpressure, which is located on the cast valve.***

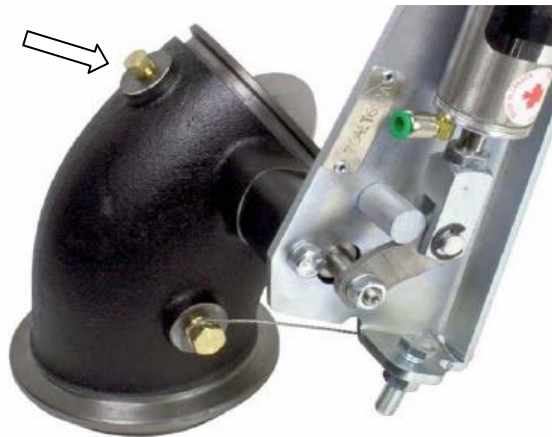

### **Idle Pressure Test**

With the BD brake engaged and the engine at idle check the exhaust backpressure using a pressure gauge (such as BD PN 1030050) at the test port on the brake valve.

If the back pressure is below 13 psi at idle you have a number of likely causes. The most common being an exhaust leak either at the clamp joint or at the welds (only on some models). Apply the exhaust brake and have someone assist you looking for soot trails or the visible leak. Another culprit would be an exhaust manifold leak, turbocharger gasket leak, turbocharger problem or an EGR issue.

If the back pressure is greater than 25psi, you will need to make an adjustment on the stop bolt. Loosen the jam nut, and lengthen the stop bolt towards the actuator, this will shorten the stroke distance. Only turn 1/4 rotation at a time and re-secure the jam nut. Retest idle pressure.

We generally do not recommend adjusting the stop bolt, please consult BD before doing this as it may void your warranty.

BD Engine Brake Inc.

Plant Address: 33541 MacLure Rd. Abbotsford, BC, Canada V2S 7W2

U.S. Shipping Address: 88-446 Harrison St, Sumas, WA 98295 U.S. Mailing Address: P.O. Box 231, Sumas, WA 98295

Phone: 604-853-6096 | Fax: 604-853-8749 | Internet: [www.bd-power.com](http://www.bd-power.com)



**Off-Idle Pressure Test & Adjustment**

Your BD exhaust brake is a variable-orifice design so when the brake is active and the engine is at higher RPM the brake lever does not rest on the stop bolt. Off-idle backpressure is set by adjusting the air pressure regulator which will in turn increase or decrease off-idle exhaust backpressure. You will need to secure your pressure gauge somewhere that you can see it while you are driving. Using a long extension hose & bringing the gauge into the cab through an open window or clipping it under a windshield wiper works well.

Get the truck up to speed (a downhill grade or a load in the truck is helpful) and activate the exhaust brake. Note the maximum backpressure achieved. You should get peak backpressure at higher RPM (try 3000 RPM in Drive). If you cannot reach the desired backpressure (compare table below) you can begin troubleshooting, the first step is to look for exhaust leaks either from the clamps, exhaust manifolds or feed pipes. Also look for leaks at the clamps located at the back of the turbo and also at the down pipe. If all connections are sealed, you can then use the adjusting regulator to increase the backpressure. Note that small regulator adjustments can have a significant effect on off-idle backpressure.

Turning the regulator **clockwise** will increase pressure.

Turning the regulator **counter clockwise** will decrease pressure.



**NOTE:** Over the next two weeks, the backpressure at idle may rise due to initial carbon build up on the inside of the brake housing and on the butterfly. The stop bolt may need to be adjusted again to compensate.

Application	Maximum Back Pressure
GM/Chevy 6.5	35 psi
GM/Chevy Duramax	55 psi
Ford Powerstroke	45 psi
Dodge Cummins 1988-98 12V w/o 60lbs Springs	40 psi
Dodge Cummins 1988-98 12V with 60lbs Springs	60 psi
Dodge Cummins 2002 and Newer	60 psi

\*HD Spring part# is 1030060.

**CAUTION:** Do NOT exceed the maximum back pressure value in the exhaust system. Exceeding this pressure will force the exhaust valves open during the intake stroke which could cause engine damage.

## Air Brake Troubleshooting Guide

This guide assumes that your exhaust brake system is using a DFIV and a BD air compressor. If your system uses a microswitch for throttle activation, the operation of the air solenoid and pump are the same as with the DFIV. If you are using existing on-board air, check that system as appropriate.

<b>When I let off the throttle nothing happens.</b>	<b><u>No</u></b>	<b><u>Yes</u></b>
Is the DFIV powering its "brake" output when the throttle is at idle and brake switch and ignition are both on?	<p>Check if DFIV has good power, ground and throttle signal. Check DFIV adjustment. If these things check out, but the DFIV won't power the "brake" output, the DFIV is likely faulty.</p> <p>Also check power &amp; ground at pump relay and make sure the air solenoid has a good ground.</p>	<p>Check that when air solenoid is powered it will allow air to flow from the #2 port out the #1 port.</p> <p>Check that pump relay is powering pump. If pump has power but does not run, pump is likely faulty. Check for power &amp; ground at pump relay, if these are good but relay does not click or does not power pump, relay is likely faulty.</p>
<b>The brake comes on but there's little or no holdback</b>	<b><u>No</u></b>	<b><u>Yes</u></b>
<p>See if torque converter is staying locked up during deceleration. If not, the engine RPM will fall to idle when the throttle is released. The brake will be ineffective without the torque converter locked up.</p> <p>Check off idle brake pressure. (See back pressure chart) Are you getting maximum allowable backpressure?</p>	<p>Check for exhaust leaks. A small leak can result in a significant decrease in back pressure. If no leaks are found try adjusting air regulator. Check for air leaks in brake system.</p>	<p>Try down shifting more aggressively. More RPM will give more holdback. Transmission or torque converter could be slipping internally.</p>
<b>Everything seems to work, but the brake valve won't close.</b>	<b><u>No</u></b>	<b><u>Yes</u></b>
Check that air is reaching brake air cylinder?	Air solenoid or quick release valve are likely stuck, plugged or faulty. Clean or replace as required.	Cylinder or brake valve are seized. Remove the clevis pin on the end of the cylinder rod & see if the valve lever can be moved freely.
The valve lever can be moved freely?	Try dismounting the brake & cleaning the carbon out of it. If this does not work the brake valve will need to be replaced.	The cylinder is stuck and will need to be replaced.
<b>Problem</b>	<b>Solution</b>	
Air compressor runs in short bursts and brake is slow to apply.	There is a restriction in the air system, normally in the regulator or air solenoid. Remove the fittings from the regulator and air solenoid, you will likely find some corrosion or debris caught in them. Clean this out with a pick, small brush, compressed air and WD40 or similar lubricant.	
Air compressor runs continually.	Pump relay is likely stuck on. Check operation of relay & replace as required.	
Brake is slow to release.	Debris or corrosion is restricting the quick release valve or air solenoid. Clean as required. Air solenoid could be too far from brake.	

BD Engine Brake Inc.

Plant Address: 33541 MacLure Rd. Abbotsford, BC, Canada V2S 7W2

U.S. Shipping Address: 88-446 Harrison St, Sumas, WA 98295 U.S. Mailing Address: P.O. Box 231, Sumas, WA 98295

Phone: 604-853-6096 | Fax: 604-853-8749 | Internet: www.bd-power.com